

INTERNATIONAL SCIENTIFIC CONFERENCE

ACCOUNTING
UDIT
NALYSIS

**TRANSFORMATION OF
SCIENCE AND BUSINESS IN
NEW ECONOMIC REALITY**

BOOK OF EXTENDED ABSTRACTS

NOVEMBER 25-26, 2021



**Vilnius
University**



**Faculty of Economics
and Business
Administration**



SCIENTIFIC COMMITTEE

Chair: Prof. Rasa Subačienė (Vilnius University, Lithuania)

Members:

Prof. **Stamatis Aggelopoulos** (International University of Greece, Greece)
Prof. **Jaan Alver** (Tallinn University of Technology, Estonia)
Prof. **Armenia Andronicea** (Bucharest University of Economic Studies, Romania)
Prof. **Svetlana Bychkova** (Saint-Petersburg State Agrarian University, Russia)
Prof. **Riccardo Beltramo** (The University of Torino, Italy)
Assoc. prof. **Fitim Deari** (South East European University, Republic of North Macedonia)
Prof. **Danuta Diskienė** (Vilnius University, Lithuania)
Assoc. prof. **Joanna Dyczkowska** (Wroclaw University of Economics and Business, Poland)
PhD **Anna Iwacewicz-Orłowska** (The University of Finance and Management, Poland)
Prof. **Cristina Góis** (Coimbra Business School of Polytechnic Institute of Coimbra, Portugal)
Assoc. prof. **Tarmo Kadak** (Tallinn University of Technology, Estonia)
Prof. **Vaclovas Lakis** (Vilnius University, Lithuania)
Prof. **Teemu Laine** (Tampere University, Finland)
Prof. **Jonas Mackevičius** (Vilnius University, Lithuania)
Prof. **Aida Mačerinskienė** (Vilnius University, Lithuania)
Prof. **Athanasios A. Mandilas** (International Hellenic University, Greece)
Prof. **Iveta Mietule** (Rezekne Academy of Technologies, Latvia)
Prof. **Algirdas Miškinis** (Vilnius University, Lithuania)
Prof. **Kaire Pöder** (Estonian Business School, Estonia)
Prof. **Ihor Rekunenko** (Sumy State University, Ukraine)
Prof. **Kristina Rudžionienė** (Vilnius University, Lithuania)
Assoc. prof. **Kastytis Senkus** (Vilnius University, Lithuania)
Prof. **Rimvydas Skyrius** (Vilnius University, Lithuania)
PhD **Dorota Sokolowska** (University of Physical Education and Tourism in Bialystok, Poland)
Assoc. prof. **Alfreda Šapkauskienė** (Vilnius University, Lithuania)
Prof. **Ruta Šneidere** (University of Latvia, Latvia)
Assoc. prof. **Daiva Tamulevičienė** (Vilnius University, Lithuania)
Assoc. prof. **Deimantė Teresienė** (Vilnius University, Lithuania)
Prof. **Eleftherios Thalassinos** (University of Piraeus, Greece)
Assoc. prof. **Erika Vaiginiene** (Vilnius University, Lithuania)
Prof. **Svetlana Vegera** (Polotsk State University, Belarus)
Assoc. prof. **Halina Waniak-Michalak** (University of Lodz, Poland)

ORGANIZATION COMMITTEE

Chair: Prof. Rasa Subačienė (Vilnius University, Lithuania)

Members:

Assoc. prof. **Ramunė Budrionytė** (Vilnius University, Lithuania)
J.assist., PhD student **Daiva Raziūnienė** (Vilnius University, Lithuania)
Assoc. prof. **Kastytis Senkus** (Vilnius University, Lithuania)
Assoc. prof. **Daiva Tamulevičienė** (Vilnius University, Lithuania)
PhD **Linas Tarasonis** (Vilnius University, Lithuania)

Copyright © 2021 [Authors]. Published by Vilnius University Press. This is an Open Access article distributed under the terms of the Creative Commons Attribution Licence, which permits unrestricted use, distribution, and reproduction in any medium, provided the original author and source are credited.

The bibliographic information of this book is available in the National Bibliographic Databank of the Martynas Mažvydas National Library of Lithuania (NBDB).

ISBN 978-609-07-0672-5 (digital PDF)

<https://doi.org/10.15388/Transformation-of-science-and-business.2021>

Contents

Keynote presentations	5
<i>Arbidane Iluta, Puzule Anita</i> . Current Asset Management Methods and Their Application: Case of Latvia	14
<i>Bachtijeva Diana, Tamulevičienė Daiva</i> . The Similarities and Differences of Earnings Management and Creative Accounting: a Theoretical Comparative Study	17
<i>Bielinė Viktorija, Ulbinaitė Aurelija</i> . Capturing Value in the Ecosystem of Digital Business Platforms	20
<i>Būmane Inga, Joppe Aina</i> . Tax Policy Measures to Combat the Covid-19 Pandemic ...	25
<i>Čirba Karolis, Raziūnienė Daiva</i> . Identification of Factors for Big Data Application in the Financial Audit	29
<i>Cohen Viktorija, Šabanova Diana</i> . Assessing Service-Based Innovation: a Theoretical and Practical Analysis	33
<i>Čulková Katarína, Hrehová Daniela</i> . Credit Rating Analysis of Business Consumers in the Industrial Company	36
<i>Juočiūnienė Dalia, Zinkevičienė Danutė</i> . Problematics of Allocation of Indirect Manufacturing Costs in Agribusinesses: Evidence from Lithuania	38
<i>Kadak Tarmo, Laitinen Erkki K.</i> Variations of Performance Management Systems	42
<i>Kamarauskienė Irma</i> . System of Indicators for the Financial Analysis of Public Sector Entities	45
<i>Kasperavičiūtė Ugnė, Stankevičienė Asta, Diskienė Danuta</i> . Influence of Employee Experience Conditions on Employee Engagement, Organizational Commitment and Intention to Leave the Organization	51
<i>Kotane Inta, Mietule Iveta</i> . Analysis of Business Performance Evaluation Practice at Manufacturing Sector in Latvia	56
<i>Kviklis Julius</i> . The Impact of the COVID-19 on the Stock Market: Case of Italy	59
<i>Masiulevičius Audrius, Lakis Vaclovas</i> . Application of Qualitative Characteristics to Evaluate Misstatements in Financial Statements: Evidence from Factual Audit Data	63
<i>Medekytė Kamilė, Tamulevičienė Daiva</i> . Research on the Awareness and Application of Strategic Management Accounting Instruments in Lithuanian Companies	68
<i>Pankova Svetlana, Sataškina Elena</i> . Accountant's Professional Judgment: the Uncertainty and Risks	72

<i>Paraska Olga, Ivanishena Tetiana. Methodological Bases of Life Cycle Assessment of Textile Products Cleaning Technologies at the Cleaning Industry Enterprises</i>	75
<i>Pečiūrienė Aleksandra. Undergraduate Business Students' Perceptions of Accounting Practices and Profession</i>	79
<i>Pokhylko Svitlana, Dvorianova Tetiana. A Digital Platform as a Diverged Type of Digital Business Models</i>	84
<i>Raziūnienė Daiva. Models and Factors of Auditor's Professional Skepticism</i>	87
<i>Rudžionienė Kristina, Černiauskaitė Miglė, Klimaitienė Rūta. The Impact of IFRS Adoption on Lithuanian Companies' Financial Ratios</i>	90
<i>Šalienė Asta, Tamulevičienė Daiva. Review of Performance Audit Impact Studies</i>	93
<i>Subačienė Rasa, Budrionytė Ramunė, Žemguliene Jolanta, Faituša Iveta. Evaluation of the Competencies of Modern Accounting Specialist: Cases of Lithuania and Latvia</i>	96
<i>Taburchak Alexey Petrovich, Bychkova Svetlana Mikhailovna, Butina Alina Alexandrovna. Analysis of Risk Factors for Applied Projects in the Ecosystem of Digitalization of the Economy</i>	99
<i>Turskytė Ieva, Šapkauskienė Alfreda. Bibliometric Analysis of Central Bank Digital Currency Research</i>	103
<i>Tverezovska Oleksandra, Hrytsenko Larysa. The Impact of the Level of Financial Inclusion on Ukraine's Economic Growth and Its Financial Security</i>	106
<i>Ulbinaitė Aurelija, Radzevičius Ramūnas. Relationship Between Healthcare Spendings and Life Expectancy in the USA</i>	111
<i>Ulbinaitė Aurelija, Raštutytė, Neringa. How Social Business Sustainability Relates to Consumer Purchase Decision</i>	116
<i>Vegera Svetlana, Sushko Volha. Industrial Waste Accounting at the Life-Cycle Stages in the Concept of Green Economy</i>	120
<i>Žemguliene Jolanta, Valukonis Mantas. Organizational Competence in Managing Transformation</i>	124
<i>Žukauskaitė Deimantė, Daujotaitė Dalia. Identification and Assessing Risks of Material Misstatement of the Financial Statements</i>	128

Keynote presentations

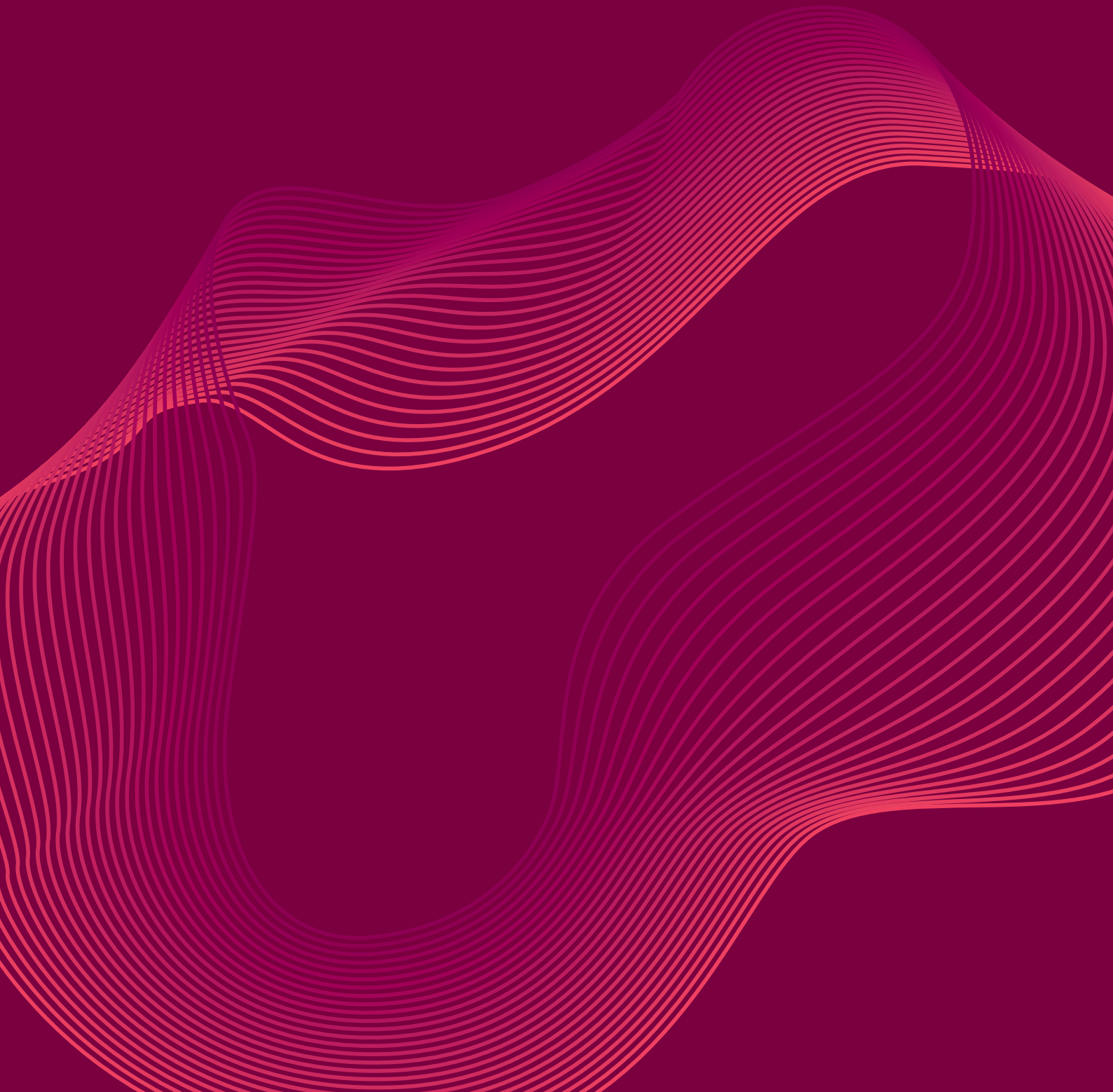



PhD Ramona Rupeika-Apoga
Professor (University of Latvia)

PhD **Ramona Rupeika-Apoga** is a Professor of Finance at the University of Latvia and the Head of the Department of Finance and Accounting. She has led and participated in several studies and research projects internationally and locally. She has more than 15 years of pedagogic experience in Latvian and European higher education institutions with specialization in Risk management, International Finance, FinTech, and Digital transformation of SMEs. She is an expert in Economics and Management Sciences of Latvian Academy of Sciences and the author of a great number of articles, an editor at five international scientific journals.

Digitalise or Die: the Digital Transformation of Companies

COVID-19 has significantly speeded up the process of digital transformation in Europe. Companies that were previously hesitant to digitalize their businesses can no longer wait to do that to prevent them from disappearing from the market. Digital transformation is not just about going online or doing e-commerce. Digital transformation is a process that changes the entire business model of companies and that needs to be supported by an ecosystem, a dedicated digital strategy, and digital skills. At the same time, successful digital transformation requires companies to address a number of resource challenges. Digital transformation can require new and sometimes significant investments in the company, employees, and customers, all under budget constraints.

Prof. Ramona Rupeika-Apoga will present the research results based on data collected from the owners and CEOs of 434 SMEs, which are registered in Latvia, and responded to an online survey carried out during February/March 2021. The main conclusion is that the degree of digitalization of Latvian small and medium-sized enterprises is rather low. For example, over 80% of surveyed companies still use telephone and email for business. The survey results convincingly showed that the most acute problem in Latvia is the lack of funding. 72% of all surveyed SMEs said they did not have enough money to drive digital transformation in companies. The second obstacle was the lack of digital skills among entrepreneurs, 69% of companies consider this a burden, but this was not as acute as the lack of funding. In terms of the impact of digital transformation on business in the next five years, the vast majority of entrepreneurs believed that digital technology would have a positive impact on business (93% of SMEs), but would require digital technology to remain competitive (91% of SMEs).

The research findings provide some practical implications for SMEs for better planning and managing their resource actions, which are essential steps towards successful business transformation.

This research is funded by the Latvian Council of Science, project DigiSMEs, project No. LZP-2020/2-0061.



PhD Julita Wasilczuk
Associated professor
(Gdansk University of Technology)

Ph.D. **Julita Wasilczuk** is an associate professor of Gdansk University of Technology, Faculty of Management and Economics (Poland), she is the leader of scientific projects dealing with the entrepreneurship of students, non-technological innovations, growth of firms, unproductive entrepreneurship. Since 2008 she has been the leader of the international panel project Survey on Entrepreneurial Attitude of Students. She is the founder and chief editor of scientific journal *Research on Entrepreneurship in Modern Economics (REME)*, a member of scientific boards of other scientific journals, actively participates in the activity of international organizations, has published more than 100 publications.

Abide, Avoid or Alter – Influence of Institutions on Tax Morality

The presentation will deal with the relation between the quality of institutions and tax morality, especially in transition or just after the transition countries. It would refer to the dependency of modern entrepreneurship from institutions, which regulate, enable or make life difficult for entrepreneurs, in almost every aspect, including taxes. The theoretical background will be based on the New Institutional Economy, which precisely refers to the concept of institution.

One of the elements inherent in running a business is paying taxes. This unpleasant duty for most entrepreneurs is not always performed in compliance with the regulations prevailing in individual countries. Assoc. professor PhD Julita Wasilczuk will present the results of the research conducted on 270 entrepreneurs in Poland which shows that tax avoidance does not always result from rent-seeking. Often this is an action forced by institutions, the entrepreneur, having the choice of meeting the tax obligation and bankruptcy (resulting from the inefficiency of the institutions - not necessarily related to tax), decides to circumvent the regulations - simply speaking cheat.



Jonas Akelis
Managing Partner of EY
in the Baltic States

Jonas Akelis has significant experience in audit, reorganisation and privatisation, transactions, strategy, performance improvement and measurement engagements for local, international, public and private companies and NGOs. He has experience in a range of industries - Utilities, Communications, Media and Entertainment, Transportation, Production and others.

Jonas is a Certified Public Auditor of the Republic of Lithuania and a member of the ACCA (UK). He has been a board member of the Investors' Forum in Lithuania since 2009. Jonas earned a Master's degree in Accounting and Auditing from Vilnius University, Lithuania.

"Despite all innovations and disruptions, our future will always be the next generation. Our personal and corporate responsibility is to continuously share our knowledge and experience with the younger generation and involve them in challenging assignments to continue learning. I take great pleasure in spending time with, sharing with and learning from younger generations".

Audit of the Future: How are Today's Challenges Bringing Forward the Audit of Tomorrow?

Business and societies in general only work if there is trust, and that means trust across all aspects of the corporate governance and reporting ecosystem. High-quality, independent assurance is an important element in supporting that trust. Corporate reporting and audit need to evolve to support the need for stakeholders to trust aspects of a company's business and behaviors that go beyond just how its finances are managed. For auditors to meet this challenge, a wide range of skills is needed. This can best be delivered by a multidisciplinary practice and teams, but the responsibility isn't solely that of auditors. All participants in the corporate governance and reporting ecosystem have a role to play in delivering the evolution needed



Kristina Jakštonytė
Head of Innovation and Methodology
Department in the National Audit
Office of Lithuania

Kristina Jakštonytė has a master's degree in the field of Accounting and Audit, which she obtained in Vilnius University. She has been working in the National Audit Office since 2001 on various positions – starting as a financial auditor and becoming methodologist in the same field, then turning attention to strategic planning and monitoring and later on leading one of the performance audit departments. Currently Kristina is a head of newly established Innovation and Methodology Department.

Assessment of Audit Impact – Qualitatively New Approach to Assess the Benefits State Audit Brings to Public

Presentation will cover System of monitoring of implementation of state audit recommendations with the main focus on newly introduced Assessment of audit impact. We, as a Supreme Audit Institution, believe, that it is no longer enough to only assess whether our recommendations have been implemented. We want to know, based on data, whether our audits have had positive impact on the public sector and, where possible, what is the size of this impact. Starting mid of 2020, we have introduced new element in our audit report's – indicators, upon which we will be measuring changes, caused by implementing our recommendations. Those indicators are discussed and agreed with auditees. Based on this new information, National Audit Office of Lithuania is striving to have a clear map of changes in the public sector, caused by our work, as well as to be able to assess state audit's financial impact.



Aušra Miltenytė
Digital Transformation & Innovation
Director, PwC Lithuania

Aušra Miltenytė has 18 years of experience in tax, 3 years of experience in digital and is currently leading PwC Lithuania digital transformation and innovation activities focused on creating value with digital mindset and solutions internally and externally.

New World. New Skills. Auditors and Accountants that Develop Robots

Enabling citizen-led automation when subject matter experts create their own process automations has proven to be a valuable addition to the overall digital transformation strategy of businesses. Given the right digital upskilling programs and the right tools, auditors and accountants create robots and other automation tools without having to fully rely on usually limited technology developers' resources. Such an endeavor scales overall business automation efforts and contributes to empowerment of auditors and accountants to escape manual routine data tasks, perform more with less and focus on activities that add the highly wanted value to the business.

Aušra Miltenytė will share PwC Lithuania experience with implementing citizen-led automation, or in other words, empowering auditors, accountants, tax professionals to create and welcome Karvelis (a.k.a. Pigeon), Pūkis (a.k.a. Fluffy) and many other digital co-workers and tools into our daily lives with less routine and more creativity.



PhD Audrius Linartas
Executive Director The Authority of
Audit, Accounting, Property Valuation
and Insolvency Management (AVNT)

PhD **Audrius Linartas** began his carrier at the Insurance Supervisory Commission, where he had collected a deep knowledge of insurance finance and accounting. Now he is the head of AVNT - regulatory authority responsible for state supervision of auditors, valuers and insolvency managers in Lithuania. For many years he has been the member of the Committee of Business Accounting Standards, which are applied for financial reporting by more than 95 percent of profit seeking companies in Lithuania.

Audrius earned a PhD degree in Economics at Vytautas Magnus university in 2013, He had worked as Associated Professor at Mykolas Romeris University where his area of interest had been the International Financial System. Since 2016 Audrius has been working at Vilnius University as Partnership Professor teaching Financial Analysis.

Since 2020 he has been appointed the Member and from this year the Chairman of the Audit Committee at European Investment Bank, which is the largest multilateral development bank (MDB).

New ESG Disclosures to Change Business Perception

Today we see the new developments that are changing our perception about what is the best business practice when a company wishes to disclose the information on its financial activities. Historically, we were used to seeing financial companies to disclose the financial information by publishing their annual reports concentrated on presenting how the company's activity had changed the financial position and the profit of this company. Now main stakeholders of financial companies expect to receive additional, more systemically arranged and comparable ESG information.

EU Non-Financial Reporting Directive (NFRD), which came into force in 2014, has laid down the basic rules on disclosure of non-financial and diversity information. But the modern society is more and more concerned about the company's activity impact on environment and sustainability. ESG policy is therefore becoming the hot topic of modern financial market.



PhD Marius Lanskoronskis
Executive Director Lithuanian Chamber
of Auditors

PhD **Marius Lanskoronskis** has spent around 15 years in business consulting sector in Lithuania and abroad, also was working in several managerial positions in public sector. Most of the implemented projects and gained competencies cover areas of public sector efficiency and value chain creation in business investments.

Marius has earned a PhD degree at ISM University of Management and Economics in 2009. Since then is giving lectures in several Lithuanian universities in the topics of strategy and business management.

Marius has also earned the certificate of internal auditor, since 2014 is a member of Social Science Expert board at the Agency of Science, Innovations and Technology.

Digitalisation and Automatization in Audit and Accounting Professions. Opportunities and Challenges

Current global environment is highly fostering computerisation, digitalisation, automatization and robotisation both in public and private sectors. In this context auditors and accountants have to rethink their ways of work as information gets outdated faster than ever before. Business developers, investors demand more recent and wider scope relevant and trustworthy information. To respond to this, services providers have no other choice than to employ digital technologies.

Technologies open opportunities to collect and analyse data from much wider scope of sources, to deal with extremely increasing numbers of different kinds of data. But at the same moment these trends highlight a challenge and demand for highly skilled analysts to interpret that data and transform it into information understandable for different stakeholders. Manipulation of data is another important issue audit and accounting profession has to deal with.

Abstracts

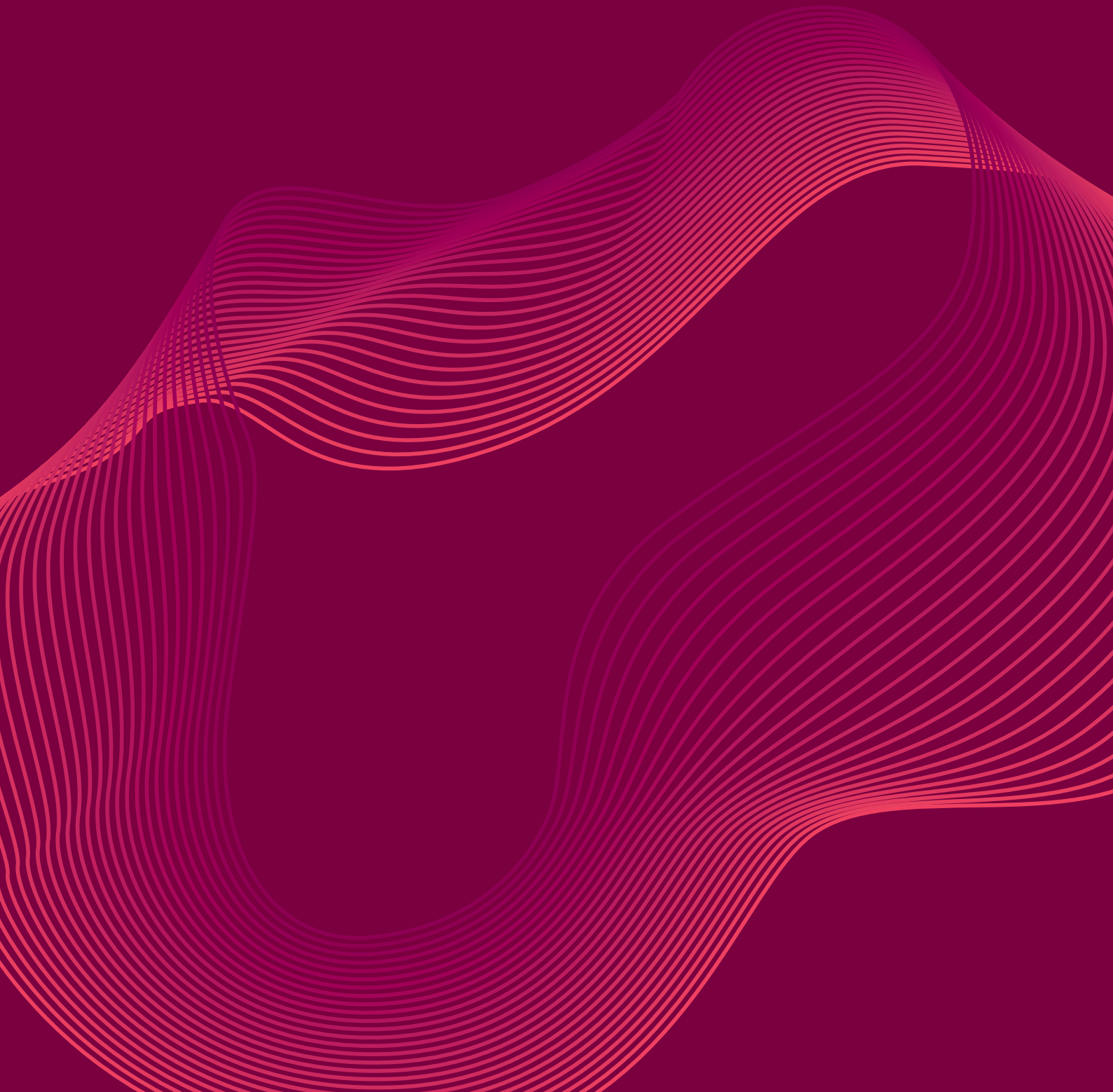

Current Asset Management Methods and Their Application: Case of Latvia

Iluta Arbidane

Rezekne Academy of Technologies, Latvia
E-mail: iluta.arbidane@rta.lv
ORCID iD: 0000-0002-9762-3874

Anita Puzule

Rezekne Academy of Technologies, Latvia
E-mail: anita.puzule@rta.lv
ORCID iD: 0000-0002-8816-5162

Keywords: current assets, current asset management, current asset management methods.

JEL code: G39, M21.

Introduction

In order to ensure the companies' financial sustainability in current economic conditions, a successful management of the current assets is crucial. In practice, it is quite often observed that the decisions related to the current asset management in Latvian companies are made with the short-term perspective, without appropriate analysis. Though, an efficient management of working capital is a vital condition to increase the company's profitability. In the result of factor analysis, the main factor groups affecting the results of the current asset management in companies were identified.

The aim of the article is to explore the opinion and attitude of the companies' management regarding the practical aspects of the current asset management, as well as to explore the actual situation in the companies. The tasks of the article: evaluate theoretical viewpoints about current assets methodology; examine regularities of application of current asset management methods at enterprises in Latvia.

The object of the research is current asset management and the companies' executive managers as individuals in position to define the company's current asset management strategy and as parties being directly interested in the companies' performance. The research subject is the company's management opinions on the possibilities of the current asset management and its necessity in the company. The period of the research from 2019 to 2021.

The expert survey method, which is one of the most common methods for retrieval of the empirical information, was used in the research. Use of the method makes it possible to obtain information on the respondent's views and the actual behaviour. The correlation analysis, factor analysis and *Kaiser - Meyer - Olkin and Bartlett* test, were used in the research; trends in the current asset management and their impact on the performance of Latvian companies were examined.

1. Literature review

In the result of the study, the authors conclude that the management of the various types of current assets is an important stage of the management. In the theoretical and practical studies, the researchers and other authors most often discuss specific methodology or methods related to the management of a particular type of current assets and their application possibilities, without providing the complex evaluation of problems. That happens due to the diversity of the current assets. Understanding of the methodology for the management of various types of the current assets and its proper application are important management components since they provide an opportunity to influence the indicators describing the current asset management reflecting the efficiency of the performance results.

In the scientific and professional literature, many of the researchers agree on the choice of indicators for the current assets analysis. The current asset analysis is based on the systematic analysis of liquidity, circulation, and profitability indicators (Trach, Tuhari,

2020; Polyanskaya, 2019; Petchrompo, Parlikad, 2019; Kovalchuk, Verhun, 2019; Lim, Porrás-Alvarado, Zhang, 2019).

To achieve the goal, the current asset management is an integral part of the company's financial management affecting the company's liquidity and profitability (Zimon, 2019; Dong, Su 2010). As the Mathuva (2010) indicates, focus on the liquidity certainly reduce profitability, and vice versa.

2. Results and discussion

When comparing the respondents' assessments on the current asset management, a similar evaluation can be observed both in the selected group and in the sectors. Comparing assessments using *Kruskal-Wallis Test*, the differences can be observed in different sectors. At the enterprises of the service sector, little attention is paid to the current asset management, and on the contrary – the evaluation provided by the managers of the production and trade companies reflects the use of the current asset management methods in the companies. The obtained data the experts' survey demonstrate rather similar results and do not identify differentiation of opinions, attitudes, and assessments amongst entrepreneurs. Despite various and diverse analysis methods, in general, the results demonstrate similar and commensurate opinions, division of dispositions and assessments on the topic of tendencies of the current asset management in Latvian companies. Evaluating the criteria of each conversion indicator, the managers believe that the application of management of each element composing the working capital. Evaluating the criteria influencing profitability higher than the average 4, the significance of costs and conversion indicators is also evaluated.

Results of the Pearson's correlation analysis indicate that there is a close connection between the aspects of management of various elements of the current assets. It means that managers understand well the significance, necessity and methodology of the current asset management. Though, no relation has been observed between the implemented policy of management of current assets and its influence on the activity indicators at the enterprises and the entrepreneurs' opinion, when evaluating the desired criteria of the management of current assets and their influence on the indicators.

Conclusions

1. The management of the companies usually ground their current asset management on the general operations of the enterprise and the basic principles of the financial policy that are focused to the achievement of the basic financial indicators. The companies' management recognize significance of specific elements of the methodology of the current asset management and admit its necessity at the company. Impact of the external environment and the enterprise's ability to adapt to it are also recognized as an important factor.
2. The proposed current asset management process is complicated enough, though four main aspects can be distinguished:
 - analysis of the past events that is based on the estimates and past experience;
 - development and implementation of the current asset funding policy;
 - the current asset management in a specific place and time establishing and implementing particular policies for the management of particular types of the current assets;
 - planning of the current asset flow, establishing structure, creating the company's value.

References

1. Dong, H.P., Su, J. (2010). The relationship between working capital management and profitability: a Vietnam case. *Journal of Finance and Economics*, 49, 59–67.
2. Kovalchuk, T., Verhun, A. (2019). Improvement of the method of analysis of asset management efficiency. *Baltic Journal of Economic Studies*, 5(5), 61–66. <https://doi.org/10.30525/2256-0742/2019-5-5-61-66>
3. Lim, T., Porrás-Alvarado, J.D., Zhang, Z. (2019). Pricing of highway infrastructure for transportation asset management. *Built Environment Project and Asset Management*, 9(1), 64–79. <https://doi.org/10.1108/BEPAM-05-2018-0083>
4. Mathuva, D.M. (2010). The influence of working capital management components on corporate profitability: a survey on Kenyan listed firms. *Journal of Business Management*, 4 (1), 1–11.
5. Petchrompo, S., Parlikad, A.K. (2019). A review of asset management literature on multi-asset systems. *Reliability Engineering & System Safety*, 181, 181–201. <https://doi.org/10.1016/j.ress.2018.09.009>
6. Polyanskaya, N.M. (2018). Analysis of current assets of the enterprise: organizational and methodological framework and practical application. *Economic Analysis: Theory and Practice*, 17 (3), 539–561. <https://doi.org/10.24891/ea.17.3.539>
7. Trach, D., Tuhari, T. (2020). Improving the methodology for managing current assets of agricultural enterprises. *Journal of Research on Trade, Management and Economic Development*, 2(14), 54–63.
8. Zimon, G. (2019). The impact of quality management systems on the efficiency of current assets management in small commercial enterprises. *European Research Studies Journal*, 22(4), 308–316.

The Similarities and Differences of Earnings Management and Creative Accounting: a Theoretical Comparative Study

Diana Bachtijeva

Vilnius University, Lithuania

E-mail: diana.bachtijeva@evaf.vu.lt

ORCID iD: <https://orcid.org/0000-0003-3025-9841>

Daiva Tamulevičienė

Vilnius University, Lithuania

E-mail: daiva.tamuleviciene@evaf.vu.lt

ORCID iD: <https://orcid.org/0000-0002-0187-037X>

Keywords: earnings management, creative accounting, accounting manipulations, accounting choices.

JEL code: M49.

Introduction

Earnings management and creative accounting are widely debated in the scientific literature and create confusion when analysing the issues of manipulations. The terms “earnings management” and “creative accounting” are used both in different and in similar contexts in literature. The issues of their analysis are sometimes intertwined and it is difficult to identify which actions describe earnings management and which - creative accounting. The aim of this study is to evaluate the concepts of earnings management and creative accounting and to determine their similarities and differences. In the study, it is assumed that earnings management and creative accounting are two different phenomena which are used to characterize the manipulations of the accounting information. A comparative study of earnings management and creative accounting is carried out in three stages using theoretical research methods: genetic and historical comparison, data analysis, comparative methods, contextual analysis, analogy methods.

1. Genetic comparison of the development

In order to solve the terminological confusion, earnings management and creative accounting were brought to their original states and their origins and development were determined. As early as during the normative period of accounting science, with the emergence of new accounting concepts, profit became not only the main indicator of the company's efficiency but also the object of manipulation. Accounting practitioners quickly realized that different choices of accounting solutions could affect a company's profit without violating accounting rules. Accountant's ability to manipulate accounting figures was named “creative accounting” (Griffiths, 1986; Jameson, 1988). The science of profit manipulations

prevailing in practice was noticed a little later, in the positive period of accounting science, when the opportunity arose to study accounting practice. As empirical research has shown, companies seek to change the amount of profit, this phenomenon has come to be called “earnings management” in science (Schipper, 1989). Due to different attitudes of practitioners and researchers, the accounting manipulations aimed at changing the amount of profits became known by different terms.

2. Contextual analysis of the definitions

Bachtijeva (2021), after the literature review, grouped the definitions by authors who had examined the issues of earnings management and authors who had examined the issues of creative accounting in different periods. Using the theoretical method of data analysis, the definitions of earnings management and creative accounting provided by each author were broken down into individual statements. Applying the comparative method and analysis contextual methods, each statement in the definition of earnings management is compared to creative accounting statements according to its context. An analysis of the definitions of earnings management and creative accounting showed that identical statements or statements with the same meaning are used to define these terms. In addition, the definitions of both consist of two parts: first, it defines active actions (choice of accounting methods, rules; structuring, valuation and disclosure of transactions; choice of certain actions, manipulations, etc.), and second, implies consequences which were pursued by these actions (aimed at obtaining the desired result, providing a biased result of financial activities, obtaining personal benefits, misleading users of information, etc.). Taking the definitions of earnings management and creative accounting as well as their structure into account, it can be argued that these terms define the same phenomenon—accounting manipulations aimed at changing the amount of a company’s profits.

3. Comparison of earnings management techniques and creative accounting methods

Further analysis of the concepts of earnings management and creative accounting will compare the earnings management techniques described in the literature (Lambert, Spolem, 2005; Rahman, Moniruzzaman, Sharif, 2013; Omar et al., 2014; Jiang, 2020; Strakova, 2021 and other) with the list of ways of applying creative accounting presented by Bachtijeva (2021). For this purpose, each earnings management technique is taken, its description is analysed (what is the goal, what specific manipulations need to be performed) and compared with the list of creative accounting methods applications. A comparison of earnings management techniques and creative accounting methods showed that the earnings management techniques described in the literature define a certain system of actions, an accounting choice strategy aimed at achieving a particular accounting result, meanwhile, application of the creative accounting methods seems to detail this strategy and indicates the specific actions to be taken to put it into practice.

Conclusions

1. There is a strict analogy between earnings management and creative accounting, so we can say that these are *terms that describe the same phenomenon*. The claim that there is a difference between earnings management and creative accounting because earnings management is directed at profit manipulation whereas creative accounting is about the balance sheet manipulation would be incorrect. Due to the use of the accrual principle in accounting and the specifics of the double entry, changes in the profit amount also result in changes in the balance sheet structure. It can therefore be stated that earnings management and creative accounting describe the same phenomenon that is called by different names in the science and practice.
2. In order to solve the terminological problem of accounting manipulations and to reduce the confusion and limitation of further consideration of this issue, it is proposed to abandon not only the term “creative accounting” but other terms as well and instead to use the term “earnings management” in which the word “management” ought to be understood as a negative interference with the presentation of the company’s performance in the financial statements.

References

1. Bachtijeva, D. (2021). Manipuliacijų apskaitos informacija prielaidos, rūšys ir taikymo būdai. *Buhalterinės apskaitos teorija ir praktika*, 23, 1–15. DOI: 10.15388/batp.2021.33
2. Griffiths, I. (1986). *Creative accounting*. London: Sidgwick and Jackson.
3. Jameson, M. (1988). *Practical Guide to Creative Accounting*. London: Kogan Page.
4. Jiang Y. (2020). Meanings, Motivations and Techniques of Earnings Management. In *2020 3rd International Conference on Humanities Education and Social Sciences (ICHESS 2020)*. Atlantis Press, 141–146. DOI: 10.2991/assehr.k.201214.483
5. Lambert, C., Sponem, S. (2005). Corporate governance and profit manipulation: French field study. *Critical Perspectives on Accounting*, 16, 717–748. DOI: 10.1016/j.cpa.2003.08.008
6. Omar, N., Rahman, R. A., Danbatta, B. L., Sulaiman, S. (2014). Management disclosure and earnings management practices in reducing the implication risk. *Procedia-Social and Behavioral Sciences*, 145, 88–96. DOI: 10.1016/j.sbspro.2014.06.014
7. Rahman, M. M., Moniruzzaman, M., Sharif, M. J. (2013). Techniques, motives and controls of earnings management. *International Journal of Information Technology and Business Management*, 11(1), 22–34. Available at: <http://www.sign-ific-ance.co.uk/index.php/JASR/article/view/198>
8. Schipper K. (1989). Commentary on earnings management. *Accounting Horizons*, 3(4), 91–102.
9. Strakova, L. (2021). Motives and techniques of earnings management used in a global environment. In *SHS Web of Conferences*. EDP Sciences. 92. DOI: 10.1051/shsconf/20219202060

Capturing Value in the Ecosystem of Digital Business Platforms

Viktorija Bielinė

Vilnius University, Lithuania
E-mail: viktorija.bieline@evaf.stud.vu.lt
ORCID iD: 0000-0003-2647-2340

Aurelija Ulbinaitė

Vilnius University, Lithuania
E-mail: aurelija.ulbinaite@ef.vu.lt
ORCID iD: 0000-0001-5025-7240

Keywords: digital business model, digital platform, digital platform ecosystem, value capture
JEL code: O14, P13, Q55.

Introduction

Digital technologies, vast collection, and digitization of big data, and extensive distribution of smartphones were several of the factors that enabled widespread business digital transformation which led to the emergence of new possibilities to design and develop novel business models. Novel business models allow companies move from stand-alone organizations to multi-companies' networks (Aagaard, 2019), where the value creation mechanism lies beyond the individual company and integrates customers, partners, and other stakeholders in a mutual value co-creation process (Hein et al., 2019). A digital platform is considered as a state-of-the-art core concept and is linked to disruption business models where organizations do not produce resources but provide infrastructure for individuals and other organizations to access and/or distribute resources already in possession (Mair, Reischauer, 2017).

There exists a lack of a holistic understanding of digital business platforms' ecosystem even though related research stems – including sharing economy (e.g. Schiavone et al., 2021), gig economy (e. g. Sutherland, Jarrahi, 2018) or platform economy (e.g. Gawer, Srinicek, 2021) attracted vast attention from scholars. Specific prospect about the ability not only to create and co-create but also to distribute and, what is the most important, to capture the created value between multi-stakeholders in the digital business platforms' ecosystem is gaining attention but remains undisclosed in full.

1. The ecosystem of digital business platforms

Stakeholders of the platform can be categorized into three main groups of agents – platform owner or central actor, complementors (providers or producers), and consumers including end-users. The existing scientific literature about digital platforms' ecosystem is usually limited to product and technology perspectives where interconnected actions of different stake-

holders within the network are neglected even though stakeholders directly influence the ability of central actor to create and capture value for itself and all stakeholders within the platform (Laczko, Hullova, Needham, Rossiter, Battisti, 2019). Much of the existing business scientific literature posits that the interests, priorities, objectives, and values of stakeholders are in conflict instead of being aligned (Harrison, Wicks, 2013; Pera, Occhiocupo, Clarke, 2016) but a digital platform is able to involve different stakeholders with different interests that are potentially complementary in the network it orchestrates for value creation and value capturing (Pesce, Neirotti, Paolucci, 2019). For a holistic evaluation of value capture between stakeholders who are acting as autonomous agents, there is a need to take into consideration tensions originating from the pluralism of involved actors and their distinctive performance goals. Moreover, there is a chance that the co-created value can be captured by the platform owner for private gains. The captured value can be monetized as a result of the revenue model and cost structure (financial return), although considerations of value capture must go beyond the revenue model (Hein et al., 2020) and include non-financial return.

2. Digital business platforms in education technology sector

The education technology (EdTech) sector falls in the scope of the above research. EdTech can be characterized as a combined use of hardware, software, administrative services and online educational resources to facilitate learning (Kerssens, Dijck, 2021; Selwyn, Jandric, 2020; Williamson, Hogan, 2020). Digital platforms in the EdTech sector led to digital and data-driven business models (Hilbig, Renz, Schildhauer, 2019) materialized by for-profit companies (Komljenovic, 2021). Extensive use of data, data-driven service-ecology and disruption of innovations in the EdTech sector contributed to an explosion of different educational apps, platforms, systems, and digital services, and at the same time transformed educational landscape into a complex network creating an EdTech ecosystem (Clark-Wilson et al., 2021). EdTech is increasingly populated by agents motivated by profit, interactions and operations are happening at a global scale (Verger, Steiner-Khamsi, Lubienski, 2017). Business-oriented stakeholders of the EdTech ecosystem acknowledge emerging business opportunities, changes in operating business models and increased demand of specific skills required for the workforce (including upskilling and reskilling) together with the need for business to proceed even in unpredictable environment. Recently, the Covid-19 pandemic has served as a catalyst worldwide for the further platformization, datafication, privatization, and commercialization of the EdTech sector which, at the same time, intensified the need for an analytical investigation of EdTech as part of a global platformization trend (Kerssens, Dijck, 2021). Pandemic and post-pandemic circumstances, emerging business opportunities, increased interest, and demand together with huge investments to the sector motivate the need for further and deeper analysis of value capture in the EdTech sector.

Conclusions

A scientific gap in the case of digital business platforms' ecosystem is identified because past research followed mainly value creation or co-creation mechanisms (Constantinides, Henfridsson, Parker, 2018; Mukhopadhyay, Bouwman, 2018; Cusumano, Gawer, Yoffie,

2019; Hein et al., 2019; Park et al., 2021; Poniatowski et al., 2021) and lacked an integrative framework for measuring the impact of digital business platforms ecosystem on financial, and, as a novelty, the non-financial value capture for multi-stakeholders. Our contribution to the existing body of knowledge includes the evaluation of value capture for multi-stakeholders since existing research focuses on single agent of digital business platforms ecosystem – platform owner (Zutshi, Grilo, 2019), complementors (Tsujimoto, Kajikawa, Tomita, Matsumoto, 2018) or consumers (Bonina et al., 2021) but not on all groups of multi-stakeholders at once, having in mind the inner tensions in the digital business platforms' ecosystem due to the pluralism of existing actors. Moreover, there is a knowledge gap in how digital business platforms' ecosystem impacts value capture for multi-stakeholders in different competitive situations and different lifecycle stages of digital business platforms (Hein et al., 2020). Finally, the EdTech sector itself is relatively new and the impact of the digital business platforms' ecosystem on value capture for multi-stakeholders has not been investigated in this sector yet.

We are currently establishing such a conceptual framework that will allow modelling and evaluating the impact of digital business platforms' ecosystem on both financial and non-financial value capture for multi-stakeholders (autonomous agents) in different competitive conditions and different lifecycle stages of the platform in the EdTech sector.

References

1. Aagaard, A. (2019). Digital Business Models. In A. Aagaard (Ed.), *Digital Business Models: Driving Transformation and Innovation* (1st ed.). <https://doi.org/10.1007/978-3-319-96902-2>
2. Autio, E., Thomas, L. D. W. (2014). Innovation ecosystems. In M. Dodgson, D. Gann, N. Phillips (Eds.), *The Oxford Handbook of Innovation Management* (1st ed., 204–228). <https://doi.org/10.5437/08956308X5706003>
3. Bonina, C., Koskinen, K., Eaton, B., Gawer, A. (2021). Digital platforms for development: Foundations and research agenda. *Information Systems Journal*, (October 2019), 1–34. <https://doi.org/10.1111/isj.12326>
4. Clark-Wilson, A., Moeini, A., Anand, K., Blake, C., Cukurova, M., De Ossorno Garcia, S., Weatherby, K. (2021). Supporting small and medium-sized enterprises in the educational technology sector to become more research-minded: Introduction to a small collection. *Research for All*, 5(1), 4–15. <https://doi.org/10.14324/rfa.05.1.02>
5. Constantinides, P., Henfridsson, O., Parker, G. G. (2018). Platforms and infrastructures in the digital age. *Information Systems Research*, 29(2), 381–400. <https://doi.org/10.1287/isre.2018.0794>
6. Cusumano, M. A., Gawer, A., Yoffie, D. B. (2019). Platform versus non-platform company performance: some exploratory data analysis, 1995–2015. *Software Business, Platforms, and Ecosystems: Fundamentals of Software Production Research*, 2019(June), 171.
7. Daunorienė, A., Drakšaitė, A., Snieška, V., Valodkienė, G. (2015). Evaluating sustainability of sharing economy business models. *Procedia - Social and Behavioral Sciences*, 213, 836–841. <https://doi.org/10.1016/j.sbspro.2015.11.486>
8. Gawer, A., Srnicek, N. (2021). *Online platforms: Economic and societal effects*. <https://doi.org/10.2861/844602>
9. Harrison, J. S., Wicks, A. C. (2013). Stakeholder theory, value, and firm performance. *Business Ethics Quarterly*, 23(1), 97–124. <https://doi.org/10.5840/beq20132314>
10. Hein, A., Schrieck, M., Riasanow, T., Setzke, D. S., Wiesche, M., Böhm, M., Krcmar, H. (2020). Digital platform ecosystems. *Electronic Markets*, 30(1), 87–98. <https://doi.org/10.1007/s12525-019-00377-4>

11. Hein, A., Weking, J., Schrieck, M., Wiesche, M., Böhm, M., Krcmar, H. (2019). Value co-creation practices in business-to-business platform ecosystems. *Electronic Markets*, 29(3), 503–518. <https://doi.org/10.1007/s12525-019-00337-y>
12. Hilbig, R., Renz, A., Schildhauer, T. (2019). Data analytics: the future of innovative teaching and learning. *The ISPIIM Innovation Conference – Celebrating Innovation: 500 Years*, (June), 1–16. Retrieved from <https://www.researchgate.net/publication/333995044>
13. Kerssens, N., Dijck, J. van. (2021). The platformization of primary education in the Netherlands. *Learning, Media and Technology*, 0(2), 1–14. <https://doi.org/10.1080/17439884.2021.1876725>
14. Komljenovic, J. (2021). The rise of education renters: digital platforms, digital data and rents. *Learning, Media and Technology*, 0(0), 1–13. <https://doi.org/10.1080/17439884.2021.1891422>
15. Laczko, P., Hullova, D., Needham, A., Rossiter, A. M., Battisti, M. (2019). The role of a central actor in increasing platform stickiness and stakeholder profitability: Bridging the gap between value creation and value capture in the sharing economy. *Industrial Marketing Management*, 76(August 2018), 214–230. <https://doi.org/10.1016/j.indmarman.2018.08.010>
16. Mair, J., Reischauer, G. (2017). Capturing the dynamics of the sharing economy: institutional research on the plural forms and practices of sharing economy organizations. *Technological Forecasting and Social Change*, 125(May), 11–20. <https://doi.org/10.1016/j.techfore.2017.05.023>
17. Mukhopadhyay, S., Bouwman, H. (2018). Multi-actor collaboration in platform-based ecosystem: opportunities and challenges. *Journal of Information Technology Case and Application Research*, 20(2), 47–54. <https://doi.org/10.1080/15228053.2018.1479160>
18. Muñoz, P., Cohen, B. (2017). Mapping out the sharing economy: a configurational approach to sharing business modeling. *Technological Forecasting and Social Change*, 125, 21–37. <https://doi.org/10.1016/j.techfore.2017.03.035>
19. Park, H., Kim, S., Jeong, Y., Minshall, T. (2021). Customer entrepreneurship on digital platforms: Challenges and solutions for platform business models. *Creativity and Innovation Management*, 30(1), 96–115. <https://doi.org/10.1111/caim.12404>
20. Pera, R., Occhiocupo, N., Clarke, J. (2016). Motives and resources for value co-creation in a multi-stakeholder ecosystem: a managerial perspective. *Journal of Business Research*, 69(10), 4033–4041. <https://doi.org/10.1016/j.jbusres.2016.03.047>
21. Pesce, D., Neirotti, P., Paolucci, E. (2019). When culture meets digital platforms: value creation and stakeholders' alignment in big data use. *Current Issues in Tourism*, 22(15), 1883–1903. <https://doi.org/10.1080/13683500.2019.1591354>
22. Poniatowski, M., Lüttenberg, H., Beverungen, D., Kundisch, D. (2021). Three layers of abstraction: a conceptual framework for theorizing digital multi-sided platforms. *Information Systems and E-Business Management*, (0123456789). <https://doi.org/10.1007/s10257-021-00513-8>
23. Rietveld, J., Schilling, M. A., Bellavitis, C. (2019). Platform strategy: managing ecosystem value through selective promotion of complements. *Organization Science*, 30(6), 1232–1251. <https://doi.org/10.1287/orsc.2019.1290>
24. Sanasi, S., Ghezzi, A., Cavallo, A., Rangone, A. (2020). Making sense of the sharing economy: a business model innovation perspective. *Technology Analysis and Strategic Management*, 32(8), 895–909. <https://doi.org/10.1080/09537325.2020.1719058>
25. Schiavone, F., Mancini, D., Leone, D., Lavorato, D. (2021). Digital business models and ridesharing for value co-creation in healthcare: a multi-stakeholder ecosystem analysis. *Technological Forecasting and Social Change*, 166(January), 120647. <https://doi.org/10.1016/j.techfore.2021.120647>
26. Selwyn, N., Jandric, P. (2020). Postdigital living in the age of Covid. *Postdigital Science and Education*, 2, 989–1005.
27. Sutherland, W., Jarrahi, M. H. (2018). The sharing economy and digital platforms: a review and research agenda. *International Journal of Information Management*, 43(September), 328–341. <https://doi.org/10.1016/j.ijinfomgt.2018.07.004>
28. Thomas, L. D. W., Autio, E. (2020). Innovation ecosystems in management: an organizing typology. In *Oxford Research Encyclopedia of Business and Management*. <https://doi.org/10.1093/acrefore/9780190224851.013.203>

29. Tsujimoto, M., Kajikawa, Y., Tomita, J., Matsumoto, Y. (2018). A review of the ecosystem concept – towards coherent ecosystem design. *Technological Forecasting and Social Change*, 136(June 2017), 49–58. <https://doi.org/10.1016/j.techfore.2017.06.032>
30. Verger, A., Steiner-Khamsi, G., Lubienski, C. (2017). The emerging global education industry: analysing market-making in education through market sociology. *Globalisation, Societies and Education*, 15(3), 325–340. <https://doi.org/10.1080/14767724.2017.1330141>
31. Williamson, B., Hogan, A. (2020). Commercialisation and privatisation in / of education in the context of Covid-19. *Education International Research*, (July), 79.
32. Yaraghi, N., Ravi, S. (2017). The current and future state of the sharing economy. *SSRN Electronic Journal*, (March). <https://doi.org/10.2139/ssrn.3041207>
33. Zutshi, A., Grilo, A. (2019). The emergence of digital platforms: a conceptual platform architecture and impact on industrial engineering. *Computers and Industrial Engineering*, 136(November), 546–555. <https://doi.org/10.1016/j.cie.2019.07.027>

Tax Policy Measures to Combat the Covid-19 Pandemic

Inga Būmane

University of Latvia, Latvia
E-mail: inga.bumane@lu.lv

Aina Joppe

University of Latvia, Latvia
E-mail: aina.joppe@lu.lv

Keywords: taxation, Covid-19, 2020 crisis

JEL code: G01, H25, F60.

Introduction

The Covid-19 outbreak has led to a world - wide health crisis and a sharp drop in economic activity that has no precedent in recent history.

The biggest threat of modern business is the world's declared Covid-19 pandemic and measures related to its distribution restrictions, which have a negative impact on the economic situation both in Latvia and in the world.

Subject of study: tax policy measures to combat the pandemic.

The use of tax policy instruments and their impact on the management of the pandemic have not been sufficiently studied in economic literature.

The aim of the study is to explore tax policy measures to combat the Covid-19 pandemic and to provide proposals for improving tax incentives to overcome the pandemic and increasing economic activity.

In order to achieve the objective, the following tasks have been identified:

1. Explore the impact of Covid-19 disease in the global and Latvian economies;
2. Establishing national fiscal support measures for crisis-stricken sectors;
3. To make proposals for improving tax incentives to overcome the pandemic.

The study uses the following research methods: theoretically descriptive methods, graphic methods, economically mathematical methods.

1. Economic impact of the Covid-19 pandemic

The Covid-19 pandemic led to a much larger decline in world GDP than the global financial crisis in 2008, reaching nearly 10% in the first half of 2020 and around 3.4% overall in 2020.

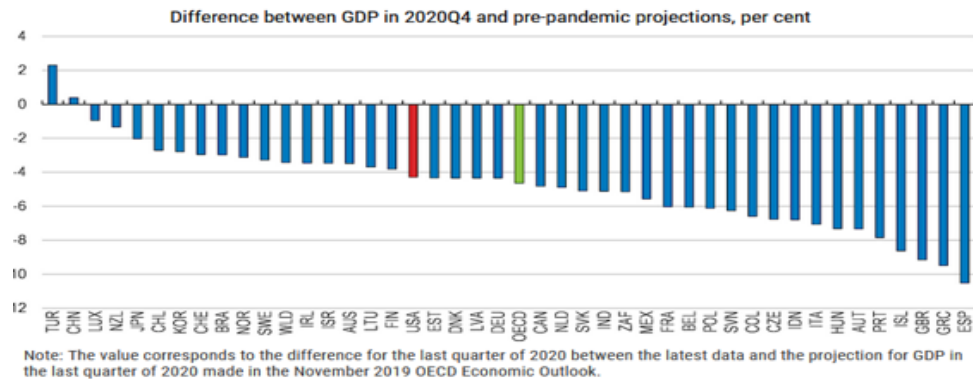

Figure 1. **The estimated output loss from the COVID crisis is large and widespread**
Source: <https://stat.link/3psw4k>

The Covid-19 pandemic and its restrictive measures in Latvia in 2020 led to a dramatic economic impact on all sectors, with the most affected sectors housing and catering services.

There are also increasing signs of divergence between countries, sectors and households.

Without reinforced political measures, both fiscal and structural, there is a high risk that the recovery could be unequal at both pace and scale between households, businesses and countries.

The amount of State aid to households and businesses has changed, but in many countries it has reached an unparalleled level. Fiscal packages often consisted of a variety of measures, including loan guarantees, job retention schemes, direct transfers, wider access benefits and tax measures. Strong and timely fiscal support has played an important role in supporting income, maintaining jobs and ensuring business activity.

In the framework of these broad fiscal packages, tax measures have played an important role in helping businesses and households in crisis situations.

2. Main tax policy trends and incentives

In the short term, the main priority will be to improve the targeting of tax incentives to ensure that aid is channelled to those most in need and to assess where it is no longer needed.

For the stimulus policy to be effective, it needs to plan carefully for time. Stimulus measures should be temporary and should focus on areas where there is possibly the largest own funds needs. In addition, the incentive policy should focus on areas where it is likely to generate additional consumption and investment. For example, targeted tax measures to support household consumption would partly subsidize spending.

Any countries have already started adopting a tax policy aimed at mitigating the economic changes caused by this crisis:

- China extends the loss carry-over period from 5 to 8 years for its companies,
- Vietnam provides five-month extension to corporate tax and value added tax,
- Thailand and Indonesia provide for calculated tax reductions in certain sectors,
- Laos implements a series of measures to overcome the crisis, releases people from labour taxes,

- for personal income tax payments, Indonesia introduces a 30 per cent corporate tax reduction and a deferral of tax payments in some sectors.

From the examples above, it can be concluded that many countries have taken radical measures to overcome the effects of the 2020 crisis. If the effects of the pandemic prove sustainable and lasting, it is unlikely that the current tax policy will adequately offset the losses caused by the crisis in most countries. As a result, this will lead to countries willing to offer ever-more generous tax incentives, seeking to secure economic growth, foreign investment.

The tax service needs the capacity, capacity to collect tax revenues to finance public health care, education and infrastructure.

Conclusions

1. The State aid programme for the reduction of the effects of the covid-19 crisis in Latvia has been developed in unrivaled conditions, following world practice and learning from its own mistakes. The overall size of the programme for heating the economy over two years is large (6.8% of the GDP of the period), and half or slightly more than two billion euro is expected to be channelled to support business.
2. Governments should also give priority to measures that support the recovery of the labour market and the recapitalization of businesses. Given the loss of jobs caused by the crisis and the risks that can affect labour markets in the long term, tax measures could be used to encourage companies to retain their employees and recruit new employees. For example, a temporary and targeted reduction in employer's social security contributions could be considered.
3. Many countries have taken radical measures to overcome the effects of the 2020 crisis. If the effects of the pandemic prove sustainable and lasting, it is unlikely that the current tax policy will adequately offset the losses caused by the crisis in most countries. As a result, this will lead to countries willing to offer ever-more generous tax incentives or applying aggressive tax policies to secure economic growth, attracting foreign investment.
4. A clear medium-term and long-term strategy on taxation and avoidance of the harmful effects of tax competition is needed and tax administrations need the capacity to collect tax revenues to finance public health care, education and infrastructure.

References

1. AF Medina. *Indonesia Issues Second Stimulus Package to Dampen COVID-19 Impact*, (ASEAN Briefing, Dezan Sira & Associates, 18 March 2020).
2. Asian Development Bank. *Asia's Journey to Prosperity: Policy, Market, and Technology Over 50 Years* (2020). Available at: www.adb.org/sites/default/files/publication/549191/asia-journey-prosperity.pdf [accessed 2 July 2020].
3. DFDL. *Lao PDR Tax Update: Latest PM Decision on Policies and Measures to Mitigate the Impact from COVID-19 Outbreak to Lao Economy*, <https://www.dfdl.com/resources/legal-and-tax-updates/dfd-lao-pdr-tax-alert-latest-pm-decision-on-policies-and-measures-to-mitigate-the-impact-from-covid-19-outbreak-to-lao-economy/>
4. DFDL. *Thailand Tax Update: COVID-19 and Tax Relief Measures in Thailand* (27 March 2020). Available at: www.dfdl.com/resources/legal-and-tax-updates/thailand-tax-update-covid-19-and-tax-relief-measures-in-thailand [accessed 20 April 2020].

5. DFDL. *Vietnam Tax Update: COVID-19 – Deferral of Taxes and Land Rental Fee Payments* (15 April 2020). Available at: www.dfdl.com/resources/legal-and-tax-updates/vietnam-tax-update-covid-19-deferral-of-taxes-and-land-rental-fee-payments/ [accessed 2 July 2020].
6. L. Lu, (2020). China Announces Tax Relief Measures to Tackle Coronavirus Disruption. *International Tax Review* [accessed 27 February 2020].
7. OECD iLibrary. *Tax Policy Reforms 2021, Special Edition on Tax Policy during the COVID-19 Pandemic*, Available at: https://www.oecd-ilibrary.org/taxation/tax-policy-reforms-2021_427d2616-en
8. VID. *Atbalsta iespējas, saskaroties ar COVID-19 izraisītām grūtībām*. Available at: <https://www.vid.gov.lv/lv/covid-19>.
9. VID. *Atbalsta pasākumi nodokļu jomā COVID-19 krīzes skartajiem uzņēmumiem*. Available at: <https://www.vid.gov.lv/lv/atbalsta-pasakumi-nodoklu-joma-covid-19-krizes-skartajiem-uznemumiem>.

Identification of Factors for Big Data Application in the Financial Audit

Karolis Čirba

Vilnius University, Lithuania
E-mail: karolis.cirba@evaf.stud.vu.lt

Daiva Raziūnienė

Vilnius University, Lithuania
E-mail: daiva.raziuniene@evaf.vu.lt

Keywords: big data, big data analytics, financial audit.

JEL Code: M42.

Introduction

Generally, the term “big data” refers to large amount of digital data that may be used to reveal issues, prospective and relations of human behaviour and actions. For instance, international and national audit companies are using big data analytics to identify risk and fraud during audits.

The purpose of the article is to identify barriers to the integration of big data into external financial audit procedures. The object of the research is big data models and their components. Tasks formulated to achieve the goal: 1) after examining the concept of big data presented by various authors, to determine the role of big data in the audit of external financial statements; 2) to identify the factors that hinder the integration of big data into audit evidence collection procedures. Research methods used in the article include the content analysis of scientific literature.

1. Big data models and the evolution of their components

Big data is large, often complex, but at the same time very fast retrieval of various types of data that are constantly changing and which processing requires advanced methods and technologies, enabling collection, storage and analysis of the information contained in such data. In recent years, big data has become especially popular in a variety of sectors, from business and government to science and research (Ajana, 2015), and as Alharthi, Krotov, and Bowman emphasize (2017), organizations around the world have increasingly realized that the ability to analyse and use large and complex data sets will be the most important source of competitive advantage in the 21st century, equivalent to gold and oil (Alharthi, Krotov, Bowman, 2017).

Accounting and auditing are not an exception, as companies face an unprecedented level of semi-structured and unstructured massive data that companies need to use and manage in order to be innovative, efficient and competitive (Dagilienė, Klovienė, 2019). On the one hand, the authors are hesitant about the possibilities and circumstances of the use of

big data in the audit of external financial statements, on the other hand, the big four audit companies have already started to use big data and allocate a lot of resources and attention to it, as well as create separate special teams within the company that work with big data and provide the already technically processed big data material to the auditors for further analysis. This facilitates the incorporation of big data into audit evidence collection procedures.

When considering the concepts and essence of big data and big data analytics, it is important to distinguish the features that are associated with big data and the concept of big data analysis. Laney (2001), the International Association of Chartered Certified Accountants (ACCA) (2013), uses the expression “Three Vs” to describe big data: Volume, Velocity and Variety (hereinafter referred to as 3V) (English - Three V’s).

Gupta, G. U., and Gupta, A (2016) distinguish 5V, and for an even more accurate definition of big data, a 7V model has been proposed (Khan et al., 2014) (see Figure 1).

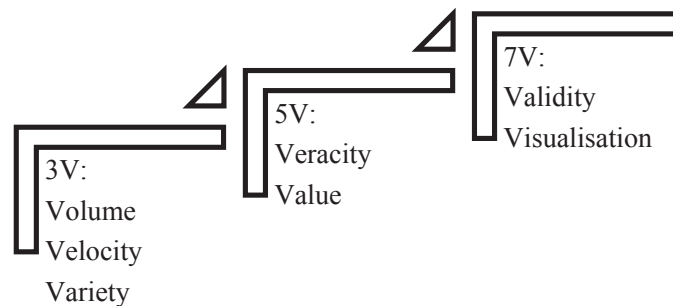

Figure 1. Evolution of the big data model

Source: compiled by the author based on ACCA, 2013; Gupta, U. G., Gupta, A., 2016; Khan et al., 2014; Laney, 2001.

Elements of models refers the amount of data, non-stopping process, not specified format, different sources, valuable knowledge, substantiated data, reliable storage of data (Khan et al., 2014; Gandomi, Haider, 2015).

2. Barriers to the integration of Big data into audit procedure

Passing from a traditional audit to a future audit using big data is not so smooth for a number of fundamental reasons, which are distinguished by different authors (see Figure 2).

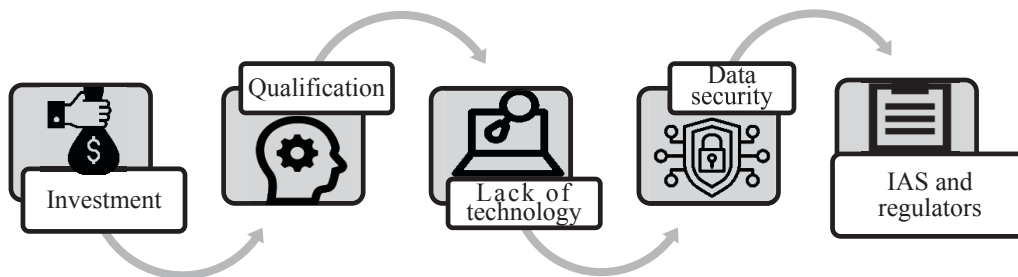

Figure 2. Barriers to the integration of big data

Source: compiled by the author based on Buchheit et al., 2020; Dagilienė, Klovienė, 2019; Tang, Karim, 2017

Dagilienė, Klovienė (2019) see audit companies as the main reasons for not understanding the strategic value of big data and big data analysis and unpreparedness of audit companies for changes due to technological, organizational and environmental difficulties. In a study carried out by Buchheit, Dzurainin, Hux, Riley (2020), audit company partners identified several additional reasons: first, it is difficult to turn new technologies not only useful but also profitable, and second, the lack of complex and generating customers, which activities would be complex and generate large amounts of data. As a result, audit professionals may need to become not only audit but also information technology experts (Tang, Karim, 2017). This leads to the next problem - the lack of competent and qualified specialists. The specialty of an auditor is characterized by its unique competencies, but the knowledge of big data analytics alone is not always sufficient, therefore it requires specialists who are able to process and understand information (Earley, 2015). The another major challenge is how investors and regulators (IFAC, IAASB, etc.) and auditing standards assess the big data.

Finally, the question arises as to how audit standards and rules can be reconciled with the use of big data analysis. The current audit standards are not based on the big data methods used in the audit of financial statements. Using comprehensive algorithms, the result may be correct, but lack of competence and ignorance of why such an analytical result was obtained do not allow reasonable conclusions to be made on which the auditor's opinion is subsequently based.

Conclusions

1. Big data is distinguished by three main characteristics: volume, velocity and variety. These are the key features to which various authors have added features such as veracity, value, validity and visibility.
2. Passing from traditional to modern audit methods is taking place in order to save costs and reduce the time spent by auditors on manual, inefficient and often repetitive procedures.
3. The main reasons for hindering the integration of big data into external financial audit procedures are related to external and internal factors. External factors are related to the size and competitiveness of the audit company, while internal ones are related to the culture, strategy of the company and opportunities to apply innovative technologies.

References

1. Ajana, B. (2015). Augmented borders: Big Data and the ethics of immigration control. *Journal of Information Communication and Ethics in Society*, 13(1), 58–78. <https://www.emerald.com/insight/content/doi/10.1108/JICES-01-2014-0005/full/html>
2. Alharthi, A., Krotov, V., Bowman, M. (2017). Addressing barriers to big data. *Business Horizons*, 60(3), 289–292. <https://www.sciencedirect.com/science/article/abs/pii/S0007681317300022?via%3Dihub>
3. Buchheit, S., Dzurainin, A., Hux, C., Riley, M. (2020). Data visualization in local accounting firms: Is slow technology adoption rational? *Current Issues in Auditing*, 14(2), 15–24. <https://meridian.allenpress.com/cia/article/14/2/A15/431445/Data-Visualization-in-Local-Accounting-Firms-Is>
4. Dagilienė, L., Klovienė, L. (2019). Motivation to use big data and big data analytics in external auditing. *Managerial Auditing Journal*, 34(7), 750–782. <https://www.emerald.com/insight/content/doi/10.1108/MAJ-01-2018-1773/full/html>

5. Dai, J., Vasarhelyi, M. A. (2016). Imagineering Audit 4.0. *Journal of Emerging Technologies in Accounting*, 13(1), 1–15. <https://doi.org/10.2308/jeta-10494>
6. Earley, C. (2015). Data analytics in auditing: opportunities and challenges. *Business Horizons*, 58(5), 493-500. <https://doi.org/10.1016/j.bushor.2015.05.002>
7. Gandomi, A., Haider, M. (2015). Beyond the hype: Big data concepts, methods, and analytics. *International Journal of Information Management*, 35(2), 137–144. <https://doi.org/10.1016/j.ijinfo-mgt.2014.10.007>
8. Gupta, U. G., Gupta, A. (2016). Vision: a missing key dimension in the 5V Big data framework. *Journal of International Business Research and Marketing*, 1(3), 46–52. <https://doi.org/10.18775/ji-brm.1849-8558.2015.13.3005>
9. Khan, N., Yaqoob, I., Hashem, I., Inayat, Z., Ali, W., Alam, M., Shiraz, M., Gani, A. (2014). Big data: survey, technologies, opportunities, and challenges. *The Scientific World Journal*, article ID 712826. <https://doi.org/10.1155/2014/712826>
10. Laney, D. (2001). 3D data management: controlling data volume, velocity, and variety. *META Group Inc.* Available at: <https://studylib.net/doc/8647594/3d-data-management--controlling-data-volume-velocity--an...>
11. Tang, J., Karim, K. E. (2017). Big data in business analytics: implications for the audit profession. *The CPA Journal*. <https://www.cpajournal.com/2017/06/26/big-data-business-analytics-implications-audit-profession/>
12. The Association of Chartered Certified Accountants, 2013. *Big data: its power and perils*. Available at: <https://www.accaglobal.com/bigdata>

Assessing Service-Based Innovation: a Theoretical and Practical Analysis

Viktorija Cohen

Vilnius University, Lithuania
E-mail: viktorija.cohen@evaf.vu.lt

Diana Šabanova

Vilnius University, Lithuania
E-mail: diana.sabanova@evaf.stud.vu.lt

Keywords: service innovation, Hertog 4D model, sport sector.

JEL code: O31, O39.

Introduction

Innovation considered to be one of the most important factors in the economic development of a company and a country. It has been extensively highlighted that the development of innovative activities, with the rise of service economy, ensures a diversified modernization of processes and increases the competitiveness in relation to its competitors, improves productivity, welfare and employment, expands international trade and economic growth. Innovation brings benefits for consumers enabling them to meet their growing needs at lower prices. Through innovation social benefits are being presented, such as the ability to address social problems more quickly and efficiently. Our understanding of the innovation process has long been related to the notion of traditional manufacturing sector, which has led to a wrong conclusion about innovations in service (Gallouj, Savona, 2009; Gallouj, Windrum, 2009) and up to today the concept of service innovation and clarity has not improved over time (Gustafsson et al., 2020). Growing service sector is driving a more important need for innovative services, and innovative processes are increasingly common in service business environments, as innovation is considered in today's world to be one of the most indispensable components of any business and an important indicator of its success. Although service innovation becomes increasingly important in consumers everyday life, there is often a problem in assessing service innovation, as the specific characteristics of services mean that they are not as easily measurable as manufacturing innovation.

The main objective of this study is to assess service innovation in sport sector using Lemon Gym sports club chain company and its customers.

1. Theoretical framework of service innovation

Service innovation is described as a new service experience or solution in one or more of the following dimensions: new service design, new customer interaction, new value system/business partners, new revenue model, new organisational or technological service delivery system (Hertog, 2010). A service is considered innovative when it differs in some feature

or use from a previous service, except routine improvements, seasonal changes and other minor changes are not considered innovation. In practice, most innovations seem to be a mix of major and minor changes and adaptations of existing services (Hertog, 2010). Tether (2005) highlights that there is not a unique pattern of innovation among firms in the service sector. Service innovation is also identified as a key source of value creation, which builds a clear customer focus (Gustafsson et al., 2020). Creating new or better value for customers is a fundamental goal of service innovation and is considered a competitive advantage for companies. This value that customers perceive and create through the use of the service is interconnected with the set of individual benefits that the service offers to its users. New services can be introduced in an already established both business or service sector and successfully improve or reshape them. However, service created value is hard to capture, especially when technology is deployed (Grant et al., 2013). The service sector comprises a wide range of activities in transportation, government, education, healthcare, social and personal services, retail and wholesale trade, entertainment, hotels and restaurants, telecommunications and finance (Randhawa, Scerri, 2015). Service innovations include new services, new service delivery processes, new organisational structures or marketing strategies (Lapenta, Sorensen, 2017) and fundamentally differs from manufacturing innovation (Drejer, 2003). Services are in most cases considered to be intangible, with no physical characteristics, it is not possible to build up a stock of services. The absence of physical characteristic in itself means that service innovations are more difficult to patent, which leads to copying and competitors. A service does not exist without a customer, who is one of the main elements of the service process. This is why it is harder to assess a service as it is measured on the basis of the user's perception and can most of the times be tested with relation to the customer's valuation. Services are heterogenic and cannot be completely identical due to the individual consumer perception and variability in service quality (Randhawa, Scerri, 2015). It is suggested that service innovation should emphasize the outcome of a development process rather than how it was realized (Gustafsson et al., 2020). As service is fuzzy and difficult to define it is also difficult to measure its output and productivity (Morrar, 2014).

2. Research framework

Using basic Hertog 4D model that classifies service innovation by four dimensions: new services, customer interface, service delivery system and technological capabilities, this paper examines features of an innovative company, identifies internal and external factors influencing implementation of innovation process aspects in a low-tech sector service-based company. Empirical study aims to assess the value of service innovations implemented by an international sport company, which operates the LEMON chain of sports clubs in the Baltic countries of Lithuania, Latvia and Estonia. A customer survey was carried out in the three countries. The survey data was collected through online questionnaire platform. Total number of respondents was 775. Data processing was carried out using SPSS (Statistical Package for Social Sciences) software. Following the analysis and interpretation of the data collected, a statistical hypothesis testing approach is applied to identify the relationships between different groups of users and the assessment of perception of service innovation. Mean, standard deviation and variance are calculated for data expressed on an interval and Likert scale, and frequencies are calculated for data expressed on a rank and nominal scale.

Cronbach's alpha coefficient is calculated to check the internal consistency of the individual scales of the questionnaire. The non-parametric Mann-Whitney U test (for two independent samples) and Kruskal-Wallis (for three or more independent samples) test are used for the comparison of the calculated Likert scale data. The χ^2 test (chi-square) is used to identify differences in responses between groups of respondents of different ages, and the proportions were additionally compared by means of a z-test.

Conclusions

The results demonstrate that customers' value perception of service innovation depends on the overall national and global environment. According to the results the global pandemic has redesigned the service innovation awareness in the sport sector, customers now give greater priority to improved hygiene, real-time monitoring of the number of customers in sport clubs, membership retention option. Some primary findings propose interesting insights that although the level of education has no effect on how service innovations is valued by customers, the age and gender of the customers do affect, which might be related to changes in general principles and lifestyle. Finally, customers that attend sport clubs less frequently value implementation of service innovation higher than the ones who attend gym on a frequent basis.

References

1. Alvarez, R., Bravo-Ortega, C., Zahler, A. (2015). Innovation and Productivity in Services: Evidence from Chile, *Emerging market finance and trade*, 51(3), 593–611. <https://doi.org/10.1080/1540496X.2015.1026696>
2. Den Hertog, P. (2010). *Managing Service Innovation: Firm Level Dynamic Capabilities and Policy Options*. Ph.D Thesis. Amsterdam Business School Research Institute, Utrecht, Netherlands. Available at: https://pure.uva.nl/ws/files/1485795/80520_05.pdf
3. Drejer, I. (2003). Identifying innovation in surveys of services: a Schumpeterian perspective. *Research Policy*, 33, 551–562. Available at: [http://www.iot.ntnu.no/innovation/norsi-pims-courses/Service-Innovation-Pedersen-Kristensson/Drejer%20\(2004\).pdf](http://www.iot.ntnu.no/innovation/norsi-pims-courses/Service-Innovation-Pedersen-Kristensson/Drejer%20(2004).pdf)
4. Gallouj, F., Windrum, P. (2009). Services and services innovation. *Journal of Evolutionary Economics*, 19, 141–148 <https://doi.org/10.1007/s00191-008-0123-7>
5. Gallouj, F., Savona, M. (2009). Innovation in services: a review of the debate and a research agenda. *Journal of Evolutionary Economics*, 19(2), 149–172. <http://dx.doi.org/10.1007/s00191-008-0126-4>
6. Grant, K., Alefantos, T., Meyer, M., Edgar, D. (2013) Capturing and measuring technology based service innovation – A case analysis within theory and practice. *International Journal of Information Management*, 33(5), 899–905. <https://doi.org/10.1016/j.ijinfomgt.2013.07.002>
7. Gustafsson, A., Snyder, H., Witell, L. (2020). Service innovation: a new conceptualization and path forwards. *Journal of service research*, 23(2), 111–115. <https://doi.org/10.1177/1094670520908929>
8. Lapenta, F., Sorensen, F. (2017). *Research methods in service innovation*. Edward Elgar Publishing Limited <https://doi.org/10.4337/9781785364860>
9. Morrar, R. (2014). Innovation in services: a literature review. *Service and Innovation*, 6–14. Available at: <https://www.timreview.ca/issue/2014/april>
10. Randhawa, K., Scerri M. (2015) Service Innovation: A Review of the Literature. In: Agarwal, R., Selen, W., Roos, G., Green, R. (eds), *The Handbook of Service Innovation*. Springer, London. https://doi.org/10.1007/978-1-4471-6590-3_2

Credit Rating Analysis of Business Consumers in the Industrial Company

Katarína Čulková

Technical University of Košice, Slovakia
E-mail: katarina.culkova@tuke.sk
ORCID iD: 0000-0002-5544-2872

Daniela Hrehová

Technical University Košice, Slovakia
E-mail: daniela.hrehova@tuke.sk
ORCID iD: 0000-0002-6601-0354

Keywords: receivables, rating, consumer, turnover of receivables, analysis of credit risk.

JEL code: L26; M21.

Introduction

Rating is generally characterized as determination of risk of not meeting the obligation, resulting from the liabilities that are made by independent rating agency. A corporate credit rating is an opinion of an independent agency regarding the likelihood that a corporation will fully meet its financial obligations as they come due. Its aim is evaluation of credibility and willingness to observe liabilities, resulting from the agreement. Credit analysis is orientated mainly to the evaluation of payment risk of the business. According to the results of the credit analysis enterprise can divide its consumers to the groups according to the business risk. Such evaluation can be expressed by simple rate that means probability that evaluated subject meet in agreed time and sum its liabilities. Final evaluation expresses by the way of rating rate from rating scale. In this case enterprises have a possibility to search bonity of the evaluated subject from the view of rating level. Any business presents certain risk and therefore rating is considered as a tool for measuring and decreasing of such risk. The importance to deal with this are results from the statistical researches, showing the struggling of the industries to get paid on time, not excluding area of support activities for mining, which is orientation of the presented research.

The goal of the contribution is to analyse if the companies use rating agencies for management of consumer's relations and to search if the enterprise use for the management of consumers relation services of rating agencies, offering possibility to verify the consumer, mainly in case consumer is not in debt register with aim the enterprise could avoid the relations with not reliable consumers and to suggest process of consumers verification and establishment of credit risk of the business. To achieve the goal we used following tools: financial analysis (involving evaluation of past and expected future financial performance with emphasis on assessment of adequacy of cash flow towards debt servicing), financial ratios (used to make a holistic assessment of financial performance of the entity, as also to see the entity's performance w.r.t. its peers within the industry), monitoring of the re-

ceivables (during of the receivables monitoring there are used indexes, such as turnover of receivables and turnaround time), analysis of the receivables through rate indexes, analysis of the receivables development in time (necessary due to the finding of the increase or decrease by various control processes with aim to avoid rising of possible risk due to the not payment of the invoice in agreed time), algorithm of the receivables management (activity of the enterprise, orientated to the optimal orientation of the receivables. The subject of the receivables management is volume of the receivables, their structure, liquidity of the receivables, subject of the receivables and risks, connected with receivables). Development of receivables in time is made according to the data from balance sheet and loss and profit statement, provided in 2015 – 2020. The data, elaborated in table and graph result from the accounting and internal documents of the analyse company GEO Slovakia, ltd. The company is orientated to the services of geophysical measurements and electromagnetic measurement, supporting tomography. The process of the research is following: during the analysis we resulted from the data of the analysed enterprise, making analysis of present state of receivables management, monitoring and registration of receivables. Consequently, we determined most risky receivables of the enterprise. From financial rate indexes we make analysis of time and speed of receivables turnover.

Research results and conclusions

The results of the analysis show to the high values of receivables turnover time, which is considered as negative situation. The results of the analysis are achieved through the analysis of present state of receivables in analyzed industrial company together with development of the receivables in time, evaluation of receivables by activity indexes, such as turnover of receivables. The results are presented by determination of risky receivables of the enterprise with aim to avoid so-called bad debts. Present state of the receivables monitoring in the analyzed enterprise showed there is no regular rating, not including detail analysis of the state and development of the financial rate indexes, evaluating development of the receivables. From the results we can state there was registered improvement of the receivables management, but following registered again decrease of the index. The highest attention the enterprises give only to the receivables in period of its enforcement, which presents unnecessary growth of the costs. In the frame of the speed of the receivables turnover we can state the smooth improving of the receivables management. According to the results the enterprise should improve management of the receivable, beginning by the regular receivables monitoring and using of credit rating. The results serve for financial management to find out measurements and recommendations for improving of relations with business partners. In the practice there are various approaches to the debtors' evaluation, for example according to the clients' bonity, according to the payment of receivables, according to the risk of receivables payment, or the enterprise could use services of rating agency. In the frame of business partner selection the enterprise should be concentrated to the clients' bonity. It means the selection is made according to the collection of information about the consumer. Since the ratings are opinions, ratings of the same company can differ among rating agencies. Corporate credit ratings can serve for the assessment of a company's ability to pay its debts according to an independent credit rating agency. Corporate credit rating trends, over time, may allow an investor to compare the credit-worthiness of competing corporations.

Problematics of Allocation of Indirect Manufacturing Costs in Agribusinesses: Evidence from Lithuania

Dalia Juočiūnienė

Vytautas Magnus University, Lithuania
E-mail: dalia.juociuniene@vdu.lt
ORCID iD: 0000-0002-6682-0445

Danutė Zinkevičienė

Vytautas Magnus University, Lithuania
E-mail: danute.zinkeviciene@vdu.lt
ORCID iD: 0000-0001-8517-9916

Keywords: indirect manufacturing costs, allocation, cost accounting, agribusinesses, Lithuania.

JEL codes: D24, M41, Q14.

Introduction

In the light of digitalization of the agricultural processes and implementation of innovations in technology, the indirect manufacturing costs have been increasing and becoming more complex to control and properly allocate to specific products. Despite the abundance of research investigating the cost accounting methods, cost classification, and indirect cost allocation to the cost accounting objects (Kontsevov, et al., 2020; Gadžo, Lalić, 2019; Tomina, Jakopiček, 2019; Frecăuțeanu et al., 2018; Oldman, Tomkins, 2018; Drury, 2015; Horngren, et al., 2012; Bogdanoiu, 2012; and others), however, the analysis of practical applications is underdeveloped, there is a lack of systematic analysis on the potential defining role of different decisions on indirect cost allocation in relation to the performance results.

Research aim: to identify the problems of allocation of indirect manufacturing costs and reveal the effect of the cost allocation alternatives on the performance results following the analysis of scientific research and practical experience of the Lithuanian agricultural entities.

Research object: allocation of indirect manufacturing costs between agricultural entities conducting agricultural operations.

Research methods. The methods of logical analysis and synthesis, questionnaire survey, case analysis, comparison and logical abstraction were used in the research.

1. The main problems of allocation of indirect production costs to cost accounting objects in agricultural entities

The conducted analysis of previous studies (Otavova, Glaserova, 2017; Scott, et al., 2016; Fisher, Marsh, 2013) has shown that, in many cases, the biological assets of a business enterprise and the agricultural products derived from them are valued at the cost consisting

of direct and indirect manufacturing costs. Indirect costs are allocated to specific cost accounting objects in proportion to the selected allocation base. According to Horngren, et al. (2012), the following key criteria of indirect cost allocation may be identified: cause and effect, value, equity, and profitability. Flood, Phelps (2003) have proposed distributing indirect costs by direct costs. Drury (2015) has noted that time has recently been the most common indirect cost allocation base worldwide. Researchers Wilson, Chua (1997) and Zimmerman (2011) have emphasized that using several indirect cost allocation bases would be reasonable, as the indirect costs of individual kinds are allocated according to the primary cause behind emergence of the respective costs. According to Cauvin, Neumann (2007), it is essential that the indirect cost allocation bases reflect the relationship between the allocated costs and the products that the costs are allocated to, production, and sales, as fairly as possible. Frecăuțeanu et al. (2018) have proposed allocating indirect manufacturing costs to crops by setting individual coefficients according to crop yield. We believe that in making decisions on indirect manufacturing cost allocation, it is essential to follow the cause-and-effect criterion, considering the production technology processes. In case identifying the cause-and-effect relationship between the output and the indirect manufacturing costs is difficult or impossible, it would be reasonable to choose a set of costs as the cost allocation basis.

In order to find out the practice of indirect manufacturing cost allocation of the Lithuanian economic entities engaged in agricultural activities, a questionnaire survey among the accountants at agribusiness entities belonging to the Lithuanian Association of Agricultural Companies was conducted. According to the survey results, 66.7% of the respondents performed accounting of direct manufacturing costs in individual accounts set up for each crop and/or animal species, and 69.8% of the respondents accumulated indirect manufacturing costs in a single account. Only 4.8% of the respondents would accumulate all production costs in a single account without classifying them into direct and indirect. The most popular basis for indirect manufacturing cost allocation referred to by the respondents was the area of cultivated crops (47.5% of respondents), direct manufacturing costs (31% of respondents) and output (21.3% of respondents). The results of the survey revealed that indirect manufacturing costs were interpreted incorrectly in practice, as almost 60.7% of respondents would attribute general and administrative costs, 34.4% – cost of sales, and 47.5% of respondents – financial operation costs to the indirect manufacturing costs. This distorts the cost of production and information in the financial statements.

2. The effect of alternatives of indirect production cost allocation on the performance of agricultural entities

The study was conducted by random selection of the enterprise specializing in crop production. It was found that in the period analyzed, about 30% of the total production costs of the enterprise consisted of indirect manufacturing costs in crop production. To allocate these costs, three alternatives for indirect manufacturing cost allocation to cost accounting objects were analyzed: alternative I – differentiated allocation bases were applied where the aim is to determine the most accurate relationship between the indirect cost items and their allocation base; alternative II – indirect manufacturing costs distributed in proportion to the direct production costs, and alternative III – indirect manufacturing costs distributed in

proportion to the area of cultivated crops. The results of the study have shown that the most appropriate approach to indirect manufacturing cost allocation would be the differentiated cost allocation bases, as the resources are not used in similar volumes for different products. Meanwhile, where indirect manufacturing costs are allocated in proportion to a single base (alternatives II and III), a share of indirect manufacturing costs are allocated to the work in progress accounting objects (winter wheat of the coming year), even though the former are unrelated to this specific cost accounting object. This shows that despite the popularity of alternatives II and III of indirect manufacturing cost accounting among the agribusiness entities, these alternatives are neither accurate nor correct. The share of indirect manufacturing costs allocated to the cost accounting objects should depend on the degree of completion of the technological process of production.

The results of the conducted case analysis demonstrated that the lowest cost of winter wheat grains was attained where the indirect manufacturing costs were allocated in proportion to the area of cultivated crops, resulting in the highest total profit indicator. The highest cost was obtained where the costs were allocated in proportion to the direct manufacturing costs, resulting in the lowest total profit indicator. The comparison of different alternatives for indirect manufacturing cost allocation showed that the biggest difference in the cost of production of winter wheat grains was 14.16%, while the difference in the total profit indicators was 2- to 3-fold. Meanwhile, the lowest cost of barley grains was calculated where the indirect manufacturing costs were allocated in proportion to the direct production costs. The highest cost of barley grains was obtained where the costs were allocated according to the differentiated bases, and the biggest cost difference between different alternatives was 8.21%. The variation of the total profit indicator for the barley grains was approximately 1.3-fold across different alternatives. In their research, Lopes (2019) concluded that the choice of the allocation base for indirect manufacturing costs affects the profitability of products, and more accurate result is generated by allocation of the costs in proportion to several bases.

For the financial statements to reflect the true and correct performance of the company it is important to choose the allocation base for indirect manufacturing costs as accurately as possible by applying the differentiated allocation bases. The differentiated allocation bases provide more accurate reflection of the use of resources by various cost objects.

Conclusions

1. The conducted case analysis has provided evidence that, where the differentiated alternative for indirect manufacturing cost allocation is selected, the indirect manufacturing costs are allocated to the cost accounting objects in the most accurate way. Meanwhile, where indirect manufacturing costs were allocated in proportion to the direct manufacturing costs or area of the cultivated crops, i.e. the most popular approach among the agricultural entities that participated in the survey, a share of indirect costs were allocated to the cost accounting objects even though they were unrelated to the respective cost accounting objects.
2. For the financial statements to reflect true and correct performance of the enterprise, it is reasonable to apply the differentiated allocation bases, as this would help establish the link between the indirect manufacturing costs and the resources used by the cost accounting object.

References

1. Bogdanoiu, C. (2012). Critical analysis of management accounting and cost calculation system from the food industry of manufacturing dairy products and ways of improving It. *Journal of Academic Research in Economics*, 2, 180–193.
2. Cauvin, E, Neumann B. (2007). French cost accounting methods: ABC and other structural similarities. *Journal of Cost Management*, 5–6, 1–14.
3. Drury, C. M. (2015). *Management and Cost Accounting*. South – Western: Cengage Learning.
4. Fisher, M., Marsh, T. (2013). Biological assets: financial recognition and reporting using US and international accounting guidance. *Journal of Accounting and Finance*, 13(2), 57–74.
5. Flood, H., Phelps, W. (2003). *Understanding Indirect Costs*. The Grantsmanship Center.
6. Frecăuțeanu, A., Cojocari, V., Bulgaru, V. (2018). The normal production capacity and the distribution of indirect costs in agriculture. *Știința Agricolă*, 2, 163–168.
7. Gadžo, A., Lalić, S. (2019). Researching impact of cost system genesis on profitability level of manufacturing enterprises. *Proceedings of FEB Zagreb 10th International Odyssey Conference on Economics and Business*, 570–583.
8. Horngren, CH. T., Datar, S. M., Rajan, M. V. (2012). *Cost Accounting. A Managerial Emphasis*. New Jersey (US).
9. Kontsevov, G. R., Ermakov, D. N., Rylova, N. I., Leoshko, V. P., Safonova, M. F. (2020). Management accounting of agricultural production: improving planning and standardization of costs in the management information system. *Amazonia Investiga*, 9(27), 284–293.
10. Lopes, R. M. S. F. (2019). Application of a multiple indirect cost pool system to a real case [online]. Available at: <https://www.repository.utl.pt/bitstream/10400.5/20433/1/DM-RMSFL-2019.pdf> [Accessed: 15 September 2021].
11. Oldman, A., Tomkins, C. (2018). *Cost Management and Its Interplay with Business Strategy and Context*. Routledge.
12. Otavova, M., Glaserova, J. (2017). The impact of changes in accounting regulations on agricultural entities and their business accounts since 2016. *Acta Universitatis Agriculturae et Silviculturae Mendelianae Brunensis*, 65(2), 689–697.
13. Scott, D., Wingard, C., Van Biljon, M. (2016). Challenges with the financial reporting of biological assets by public entities in South Africa. *South African Journal of Economic and Management Sciences*, 19(1), 139–149.
14. Tominac, S. B., Jakopiček, D. (2019). Comparison of cost calculation methods in Croatian and German healthcare system. *Proceedings of FEB Zagreb 10th International Odyssey Conference on Economics and Business*, 19–29.
15. Wilson, R.M.S., Chua, W.F. (1997). *Managerial Accounting: Method and Meaning*. London: International Thompson Business Press.
16. Zimmerman, J. L. (2011). *Accounting for Decision Making and Control*. Irwin McGraw: Hill.

Variations of Performance Management Systems

Tarmo Kadak

Tallinn University of Technology, Estonia
Email: tarmo.kadak@ttu.ee

Erkki K. Laitinen

University of Vaasa, Finland
Email: ekla@uva.fi

Keywords: Performance management systems (PMS), cluster analysis, SME, chain model; key success factors.

JEL code: M41, M10.

Introduction

Performance management systems (PMSs) play an important role in supporting management to improve and maintain performance in business firms. PMSs are regarded as efficient responses to many practical and conceptual challenges faced by organizations in dynamically changing world (Choong, 2014; Hoque, 2004; Mia, Chenhall, 1994). However, although PMSs are very popular due to their benefits, the relevant literature also points out negative aspects of implemented PMSs.

Because some firms succeed with their PMS and another firms do not, there is a keen need to understand what kinds of PMSs exist and how PMSs exactly differ from each other. PMSs in practice differ in approach (e.g. well-known PMS like BSC, Six Sigma etc; own-designed PMS etc), in content and in components that they contain. Many combinations of PMSs by approaches, contents and components make plenty of different PMSs existing in practice.

For investigating these relationships, it is necessary to create a simplified typology of PMSs and find out, what kinds of PMSs types can be found in practice. Therefore, this study concentrates on the two research questions (RQ):

RQ1: What kinds of PMS types exist in practice?

RQ2: How these types differ from each other in emphasizing different aspects inside PMSs?

1. Theoretical framework

To create this kind of empirical typology, a TwoStep cluster analysis is applied to a sample of Estonian and Finnish firms to extract the clusters. The TwoStep Cluster Analysis procedure in SPSS is an exploratory tool designed to reveal natural groupings (or clusters) within a dataset that would otherwise not be apparent. The types of PMSs are characterized by the variables extracted from the chain model developed by Kadak and Laitinen (2016).

In their approach, the fifteen KFs constitute a holistic logical chain in the developed framework. Because the success of PMS is based on the completeness of the logical chain, in a perfect PMS each KF should 1) exist (KF: 1, on) and 2) work properly. Even one missing KF (KF: 0, off) in the chain can to a certain degree lead to the failure of PMS. Therefore, the existence of each KF in the chain and its proper acting, form a kind of almost necessary or highly relevant conditions for success. The chain should be as complete as possible to make it possible for PMS to be successful.

2. Empirical data and methods

The empirical data for the study was gathered by internet questionnaires organized at the same time in spring 2015 both in Estonia and Finland among different business sector firms. We had a sample of 107 (57 + 50) Estonian and Finnish firms all together consisting a wide variety of firms with respect to industry and size. By size, from 107 respondents 43% are small (till 49 employees), 42% medium (50-249 employees) and 15% large size firms (250+ employees). The largest firm employs more than 2000 employees. In Estonia and Finland, the size distributions of firms are quite similar such that the majority of firms are small and middle-sized, and only few firms are large.

The purpose of following analyses is to find out statistically representative types of PMS and thus create an empirical typology. The TwoStep cluster analysis was carried out to extract the clusters. The TwoStep Cluster Analysis procedure in SPSS is an exploratory tool designed to reveal natural groupings (or clusters) within a dataset that would otherwise not be apparent.

The interpretation of the means of the fifteen Check Points PMS variables shows that the most significant differences in the variable means are associated with the importance of strategy and the number of organizational (hierarchy) levels in the firm. Therefore, we have entitled the four clusters in the following way (percent of the sample firms):

1. Strategy-focused Multi-level PMSs (51.4%)
2. Strategy-focused One-level PMSs (22.4%)
3. Not-strategy-focused One-level PMSs (15.9%)
4. Not-strategy-focused Multi-level PMSs (10.3%)

Conclusions

We found two important dimensions which define the archetypes of PMSs for the sample firms: importance of strategy for the firms and the multiplicity of organizational levels of firms. The results show that the most advanced PMSs are found in Strategy-focused Multi-level cluster, followed by Strategy-focused One-level cluster. The most modest PMSs are located in Not-strategy-focused One-level cluster. Strategic aspects of PMSs are more strongly emphasized in Strategy-focused than Not-strategy-focused clusters. Moreover, alignment and process aspects are more strongly emphasized in Multi-level than in One-level clusters. However, usage aspects of PMS is almost equally emphasized in Strategy-focused clusters and in Not-strategy-focused Multi-level cluster. Information aspects are most focused in Multi-level clusters and least in Not-strategy-focused One-level cluster.

The research expands understanding about the types of PMS in practise. The typology of PMSs can locate any PMS on the scale of strategy and the multiplicity of organizational levels irrespective of the approach, content, or components this system potentially includes.

These findings expand current typologies of PMS. Prior typologies are component and usage based constructions. The research adds the intrinsic features of the firm on the types of PMS, the types reflect the firm`s strategy orientation and the multiplicity of (organizational) hierarchy levels.

Clustering results of this research show that, characteristics and aspects of PMS vary between types of PMS. In consideration of mixed and contradicting consequences of PMS, this finding helps to explain these causes. If characteristics and aspects of PMSs are different, their capability to create performances does also differ. This explains, why we find in literature sometimes positive impacts of PMS on the performance of the firm and sometimes negative.

References

1. Choong, K.K. (2014). The fundamentals of performance measurement systems: A systematic approach to theory and a research agenda. *International Journal of Productivity and Performance Management*, 63(7), 879– 922. DOI: 10.1108/IJPPM-01-2013-0015
2. Hoque, Z. (2004). A contingency model of the association between strategy, environmental uncertainty and performance measurement: impact on organizational performance. *International Business Review*, 13, 485–502. DOI: 10.1016/j.ibusrev.2004.04.003
3. Kadak, T., Laitinen, E. K. (2016). What matters with PMS? Critical check points in the success of PMS. *Studies in Managerial and Financial Accounting, Performance Measurement and Management Control: Contemporary Issues*, 31, 111–140. <https://doi.org/10.1108/S1479-351220160000031004>
4. Mia, L., Chenhall, R. (1994). The usefulness of management accounting systems, functional differentiation and managerial effectiveness. *Accounting, Organizations and Society*, 19(1), 1–13. [https://doi.org/10.1016/0361-3682\(94\)90010-8](https://doi.org/10.1016/0361-3682(94)90010-8)

System of Indicators for the Financial Analysis of Public Sector Entities

Irma Kamarauskienė

Vilnius University, Lithuania

E-mail: irma.kamarauskiene@evaf.vu.lt

Keywords: public sector entity, financial analysis, financial analysis indicators.

JEL code: H83, M49.

Introduction

Financial analysis is a study of financial results and conditions of an economic entity to assess its achievements and prospective, as well as to provide qualitatively new information to financial managers that will enable them to make sound decisions. Financial analysis involves the forecasting, planning, accounting, and control of certain economic activities. Nevertheless, financial analysis is most often associated with private sector entities. The issues of financial analysis of public sector entities are examined in fragments in scientific works.

Research object: the financial analysis of public sector entities. The purpose of the research is to establish a unified and modified model of the system for conducting the financial analysis of the public sector entities. Tasks: to describe the logical sequence of financial analysis after analysing and summarising the theoretical and practical aspects of the analysis of the financial position of public sector entities; to identify and group indicators for analysing the financial position of the public sector. Research methods: analysis of scientific works, methods of information grouping, comparing, detailing, generalizing, and one-dimensional statistics.

1. Theoretical assumption for financial analysis of public sector entities

Financial analysis, as an independent science, is discussed by several foreign authors (Brag, 2013; Brealey et al., 2003; Van Horne, Wachowicz, 2005; Borodin, Mityushina, et al., 2021; Popa, et al., 2021; et al.) and Lithuanian authors (Bagdžiūnienė, 2013; Džikevičius, Jonaitienė, 2015; Mackevičius, 2009; Mackevičius, Valkauskas, 2012, 2015, 2016; Mackevičius, Valkauskas, Bachtijeva, 2020; et al.). Nevertheless, the concept of financial analysis is usually associated with the analysis of information presented in the financial statements of business entities. However, the examination of the issues of financial analysis of the public sector entities is analysed rather fragmented. The analysis of scientific works (Bunea-Bontas, Petre, 2009; Beckett-Camarata, 2009; Steiss, Nwagwu, 2001; Rivenbark, Roenigk, Allison, 2010; Villis, Kazlauskienė, 2012; Kazlauskienė 2012; Rudžionienė, 2009) displays that the unified approach to public sector financial analysis is still not present. The active reform of public sector accounting over the last decade has provided a basis for modernizing financial accounting and standardizing financial, and other reports. However, financial analysis is usu-

ally associated with the analysis and assessment of the financial health of the public sector, with the aim of adapting the framework of indicators for analysing the financial health of business entities to public sector entities. The following interrelated reasons have prompted the debate on the consistency, scope, and method of financial analysis of public sector entities as well as the attention to the results of the financial analysis and the decisions to be taken on the increasing demand for public services and the growing need for the resources needed to provide them; the public's negative perception of public sector entities as unduly spendthrift; and the desire to adopt innovative forms of management, organization, and control of business entities in the public sector. Financial information users have developed a need not only to understand the accounting information describing public sector entities, but also to compare the data of different public sector entities with each other, and to compare and evaluate the statements of financial position of public sector entities in different countries (Bikienė, 2011). The results of the financial analysis provide a basis for retrospective assessment of the entity's situation and for planning various levels and scopes of opportunities, as well as for arguing current and future strategies and decisions. Public sector entities are focused on providing public administration services and satisfying the public interest. One of the most important aspects of these entities is that their activities are financed from the state or the municipal budgets. Both internal and external information users are interested in receiving information that is as objective, complete, and relevant as possible. They are not only interested in financial performance results, but also in the economy, efficiency, effectiveness, and productivity of the public sector entities. In the year 1992, INTOSAI (International Organization of Supreme Audit Institutions) established the need for standards for internal planning, implementation, and evaluation in the guidelines for the public sector internal control standards. These standards are the basis for the 3E concept. According to Hrunza (2013), the 3E concept can be taken as a starting point for analysing public sector finances. Cost-effectiveness is about reducing the cost of resources and is linked to the ability to save. The resources used must be available on time, ensuring the best quantity, quality, and price. Efficiency can be defined as the attempt to maximize benefits by making the most efficient use of limited resources. According to Puškorius (2014), efficiency is the relationship between the desired performance outcome and the complex resources, inputs, costs, and other resources used to achieve that outcome. Effectiveness refers to the relationship between objectives or goals and the outcome. Performance measurement assesses the extent to which policy objectives have been achieved in terms of the products (services) produced. Productivity, according to Krugman (1990), is the most important indicator for quantifying the economic progress of a society. M. Jackson and Petersson (1999) define productivity as the ratio of the period of time during which a certain amount of added value has been created to the time taken to create that value. It is therefore the ratio of the results achieved to the total time needed to achieve those results (Vanagas, 2008). Public productivity is the ratio of public services provided by state and municipal authorities (public sector entities) to the resources consumed in providing those services. Given the specific nature of public sector activities and the fact that the main 'customer' of these entities is the public, four areas of activity can be distinguished: finance, administration, public interest, and development. The total productivity of public sector entities can be calculated as the sum of the results of each of the four performance areas multiplied by the corresponding weight.

2. Content and logical sequence of financial analysis

Given the particularities of the public sector, it is appropriate to start the financial analysis of public sector entities from the analysis of the financial situation and to carry it out in a consistent manner: starting from horizontal and vertical analysis, moving to relative analysis, and completing it with factorial analysis (Kazlauskienė, 2012). Scientific literature provides many examples of financial indicators and their grouping in the financial analysis of public sector entities.

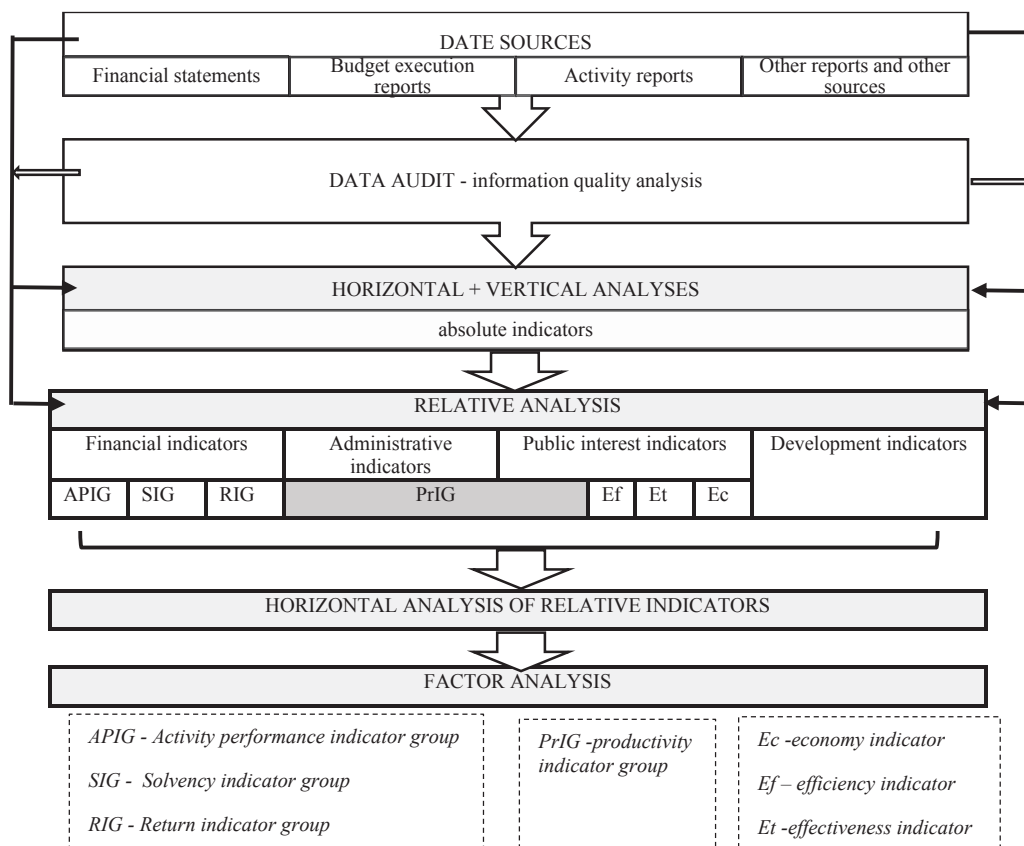

Figure 1. Structure of the system of financial analysis of public entities.

Source: compiled by author

The authors (Rivenbark et al., 2010; McKinney, 2004; Chaney, 2005; Brown, 1995; Rudžionienė, Juozapavičiūtė, 2013; Jusytė, Kamarauskienė, 2014; etc.) mention various groups of relative indicators in their works: liquidity, income and expenses, solvency, etc. McKinney (2004) presents the Financial Health Monitoring System, which includes 36 financial indicators. Brown (1993) The Municipal Financial Health Methodology includes ten indicators grouped into four categories (revenue, expenditure, current position, and debt indicators). The expert model (Chen et al. 2012) includes 14 indicators grouped into three groups (revenue, expenditure, liability indicators). Kamarauskienė and Jusytė (2014) in their work distinguish 18 indicators grouped into three groups (performance, solvency and return indicators). Kazlauskienė (2012) identifies 11 indicators grouped into five groups (liquidity, turnover, income-expenditure, debt and return indicators).

However, there is no well-established, unified system of public sector indicators and their grouping. The person carrying out the financial analysis of the entity shall select, considering the needs of the users of the information, the system of indicators best and most accurately reflecting the objectives of the analysis. Therefore, in the opinion of the author of the work, it is appropriate to group the indicators according to the activities of the public sector entity: groups of indicators of finance, administration, public interest, and development, selecting or setting indicators corresponding to each group.

It is worth noting that although there is a large number of relative indicators, they are all calculated and analysed based on the same sources of information: data from financial statements, budget execution reports, activity reports, and other reports. In line with the provisions of the Law on Public Sector Financial Reporting of the Republic of Lithuania (note: the current version will enter into force on 1 January 2022), the data from the operational and the financial reports must be correlated. Thus, a well-established system of sources of information will ensure unified data.

Conclusions

The increased need for analysis of the activities and financial situation of public sector entities is due to the reform and results of the public sector administration and the public sector accounting as well as financial reporting. It should also be noted that there is an increased demand from users of financial information to understand and compare accounting information describing public sector entities, to assess the state of the entity and to plan for different levels and scopes of opportunities, and to argue for current and future strategies and decisions.

The analysis of the literature has shown that there is still no unified approach to the financial analysis of public sector entities. There is still a lack of more comprehensive, in-depth scientific, and practical research on these issues. In particular, the work of Lithuanian authors does not give sufficient attention to the financial analysis of public sector entities.

Having summarised the methods and indicators of financial analysis of public sector entities presented in the works of foreign and Lithuanian authors, as well as evaluated the specifics of the activities of public sector entities and the specifics of the sources of information, it is proposed:

- start the financial analysis of public sector entities by evaluating the reliability of the content of information sources – data audit. The subsequent course of the study should include horizontal, vertical, relative and factor analysis.
- grouping the indicators to be used for the analysis of entities in the public sector by area of the entity's activity: financial, administrative, public interest, and development indicators. For each group, choosing or defining relative indicators corresponding to it.

The practical application of the financial analysis system provided, the setting of thresholds and targets for specific indicators, is the subject of further research by the author.

References

1. Bagdžiūnienė, V. (2013). *Finansinių ataskaitų analizė: esmė ir verslo situacijos*. Vilnius: Conto litera.
2. Beckett-Camarata, J. (2009). Local government measurement and use of performance accounting and financial reporting data in planning and budgeting decision support. *Public performance and Financial Management*, 33(2), 255–265.
3. Bikienė, J. (2011). Viešojo sektoriaus apskaitos ir finansinės atskaitomybės standartų įgyvendinimo praktikoje problematika. *Verslas: teorija ir praktika*, 12 (2), 131–140.
4. Borodin, A., Mityushina, I., Streltsova, E., et al. (2021). Mathematical modeling for financial analysis of an enterprise: motivating of not open innovation. *Journal of Open Innovation: Technology, Market and complexity*, 7(1), 79. <https://doi.org/10.3390/joitmc7010079>
5. Brag, S. (2013). *Financial Analysis. A Business Decision Guide*. John Willey and Sons Ltd.
6. Brealey, R.A., Myers S.C., et al. (2003). *Fundamentals of Financial Management*. 12 ed. Prentice Hall.
7. Brealey, R.A., Myers, S.C. (2003). *Principles of Corporate Finance*. 7th ed., McGraw-Hill, New York.
8. Brown, K. (1993). The 10-point test of financial condition: toward an easy-to-use assessment tool for smaller cities. *Government Finance Review*, 9 (6), 21–26.
9. Bunea-Bontas, C., Petre, M.C. (2009). Arguments for introducing accrual based accounting in the public sector. Available at SSRN, DOI: <http://dx.doi.org/10.2139/ssrn.1491663>
10. Chaney, B.A. (2005). Analysis of the financial condition of the city of Corona, California: using a case to teach the GASB 34 government-wide financial statements. *Journal of Public Budgeting, Accounting and Financial Management*, 17(2), 180–201.
11. Džiukevičius, A., Jonaitienė, B., (2015). Finansinių santykių rodiklių geriausiai įvertinančių skirtinguose Lietuvos sektoriuose veikiančias įmones, paieška. *Verslas: teorija ir praktika*, 16(2), 174–184. <https://doi.org/10.3846/btp.2015.533>
12. Hruza F. (2013). Why traditional financial analysis tools and approaches are not suitable for municipalities and should be re-designed? *International Journal of Social Science and Humanity*, 3(1), 57–61.
13. Jackson, M., Petersson, P. (1999). Productivity – an overall measure of competitiveness. *Proceedings of the 2nd Workshop on Intelligent Manufacturing Systems*, Leuven.
14. Kamarauskiene, I., Jusyte, J. (2014). Viešojo sektoriaus subjektų finansinių ataskaitų santykinė analizė: teoriniai ir praktiniai aspektai. *Buhalterinės apskaitos teorija ir praktika*, 16, 63–77.
15. Kazlauskienė, L. (2012). Viešojo sektoriaus subjekto finansinės būklės analizės rodiklių sistema. *Ekonomika ir vadyba: aktualijos ir perspektyvos*, 4(28), 168–176.
16. Kazlauskienė, L., Villis, L. (2012). Viešojo sektoriaus finansinių ataskaitų analizės aspektai. In *Accounting, Audit, Analysis: Science in the Context of Innovation and Globalization*. International Scientific Conference Research papers, Part II, 795–804. Available at: https://www.3akonferencija.evaf.vu.lt/media/attachments/2021/04/13/3a_research-papers-ii-part-2012.pdf
17. *Lietuvos Respublikos viešojo sektoriaus finansinės atskaitomybės įstatymas* (2007). IK 1071010ISTA00X-1212, aktuali redakcija nuo 2021-01-01.
18. Mackevičius, J. (2009). *Finansinių ataskaitų auditas ir analizė: procedūros, metodikos ir vertinimas*. Vilnius: TEV.
19. Mackevičius, J., Valkauskas, R. (2012). Įmonės finansinės būklės analizės metodika naudojant sudėtinį rodiklį. *Tarptautinis verslas: inovacijos, psichologija, ekonomika*, 3(1), 168–180.
20. Mackevičius, J., Valkauskas, R. (2015). Lyginimo būdo naudojimas finansinėje analizėje. In *Accounting, Audit, Analysis: Science, Studies and Business Synthesis*. International Scientific Conference Research papers, 223–232. Available at: [Accounting-1.indd \(vu.lt\)](Accounting-1.indd (vu.lt))
21. Mackevičius, J., Valkauskas, R. (2016). Finansinės analizės informacijos patikimumo nustatymo metodika. *Informacijos mokslai*, 76, 82–95. <https://doi.org/10.15388/Im.2016.76.10383>
22. Mackevičius, J., Valkauskas, R., Bachtijeva, D. (2020) Laiko eilutės interpoliacija ir jos metodų taikymas atliekant finansinę analizę. *Buhalterinės apskaitos teorija ir praktika*, 21, 6. <https://doi.org/10.15388/batp.2020.21>
23. McKinney, J.B. (2004). *Effective Financial Management in Public and Nonprofit Agencies*. Praeger Publishers.

24. Popa, D.N., Popa Sabau, C.D., et al. (2021). Composite financial performance index prediction—a neural networks approach. *Journal of Business Economics and Management*, 22, 277–296. <https://doi.org/10.3846/jbem.2021.14000>
25. Puškorius, S. (2014). *Veiklos auditas*. Vilnius: Lietuvos teisės universitetas.
26. Rivenbark, W.C., Roenigk, D.J., Allison, G.S. (2010). Conceptualizing financial condition in local government. *Journal of Public Budgeting, Accounting and Financial Management*, 2(2), 149–177. <https://doi.org/10.1108/JPBAFM-22-02-2010-B001>
27. Rudžionienė, K. (2009). Finansinių ataskaitų elementų įvertinimo būdai viešojo ir privataus sektoriaus apskaitoje. *Ekonomika ir vadyba: aktualijos ir perspektyvos*, 2(15), p. 227–236.
28. Rudžionienė, K., Juozapavičienė, T. (2013). Quality of financial reporting in public sector. *Socialiniai mokslai*, 4 (82), 17–25. <https://doi.org/10.5755/j01.ss.824.6609>
29. Steiss, A.W., Nwagwu, O.C. (2001). *Financial Planning and Management in Public Organizations*. Marcel Dekker, pub. Routledge.
30. Vanagas, P. (2009). *Darbo organizavimas, normavimas ir atlyginimas už darbą*. Kaunas: Technologija.

Influence of Employee Experience Conditions on Employee Engagement, Organizational Commitment and Intention to Leave the Organization

Ugnė Kasperavičiūtė

Vilnius University, Lithuania

E-mail: ugne.kasperaviciute@gmail.com

Asta Stankevičienė

Vilnius University, Lithuania

E-mail: asta.stankeviciene@evaf.vu.lt

ORCID iD: <https://orcid.org/0000-0002-8482-4191>

Danuta Diskienė

Vilnius University, Lithuania

E-mail: danuta.diskiene@evaf.vu.lt

Keywords: employee experience, employee experience conditions, employee engagement, organizational commitment, intention to leave the organization.

JEL code: M51, M54.

Introduction

Theorists and business practitioners observe that traditional human resource management strategies results do not live up to expectations. Historically, human resources have solved recruiting, training, performance, turnover challenges separately with different tools, methods, and solutions. Such fragmented human resource management does not match to today's employees needs and is more focused on eliminating the consequences than identifying the causes (Bersin, 2017). Employee experience as a new and broad holistic approach to the employee and his/her place in the organization, can help meet new challenges and ensure employee satisfaction, inclusion, well-being (Bersin, 2017). Although the topic of employee experience began theoretically (Morgan, 2017, 2018; Plaskoff, 2017; Maylett, Wride, 2017; Alshathry, Clarke, Goodman, 2017; Auriemmo, et al., 2018; Mascarenhas, 2019; Kihlström, 2020) and empirically researched only in the last five years, there are already several studies examining the relationship between employee experience conditions and employee engagement, loyalty, intention to leave the organization, employee turnover (Foresee, 2014; Maylett, Wride, 2017; IBM & Globoforce, 2017; Shenoy, Uchil, 2018; Jalaja, Padashetty, 2018; Durai et al., 2018; Pandey, Gupta, 2020). The novelty of the employee experience paradigm leads to first research in Lithuania exploring what is the relationship between employee experience conditions, employee engagement, organizational commitment and intention to leave the organization?

The aim of the research: to determine the conditions of employee experience impact on employee engagement, organizational commitment, and intention to leave the organization.

To achieve the aim of the research, the following tasks are set: 1. To measure the links between employee experience conditions, employee engagement, organizational commitment and intention to leave the organization. 2. To evaluate the impact of employee engagement and organizational commitment as mediators on employee experience conditions and intention to leave the organization relation. 3. To examine the impact of employee experience conditions as a moderator on employee engagement, organizational commitment and intention to leave the organization relations.

1. Methods

In order to examine the links between the employee experience conditions, employee engagement, organizational commitment, and intent to leave the organization, this research has applied a quantitative methodology.

The research sample was selected by convenience sampling, which is widely used in academia. In order to ensure a sufficient sample size and to motivate respondents to participate qualitatively, lottery as the motivational tool was used. The quantitative survey involved 239 respondents from the general insured working in Lithuania population.

Data was collected with a self-administered, structured survey instrument, analyzing participants' evaluation of employee experience conditions, based on five-dimensional construct of employee experience conditions developed by the author (Cronbach's $\alpha = 0.88$, Bartlett's test of sphericity - $p < 0.001$; KMO = 0.850); employee engagement based on the Utrecht Work Engagement Scale (UWES - 9) (Schaufeli et al., 2002) (Bartlett's test of sphericity - $p < 0.001$; KMO = 0.906); employee organizational commitment based on the 9 statements Meyer et al. (2012) organizational commitment questionnaire (Bartlett's test of sphericity - $p < 0.001$; KMO = 0.744); intention to leave organization based on Tett and Meyer (1993) construct of intention to leave organization (Bartlett's test of sphericity - $p < 0.001$; KMO = 0.755). At the beginning of the survey was included a control question to identify whether respondent is an insured employee (employed or civil servant). The end of the questionnaire consisted of demographic, work experience and workplace questions.

Using SPSS 26.0, data was analysed through Kolmogorov - Smirnov, Shapiro-Wilk, Mann - Whitney U, Kruskal - Wallis H tests and using Spearman's rank correlation coefficient, linear regression analysis methods. Mediator and moderator analyze were performed using the PROCESS bootstrapping method developed by A. F. Hayes with 95% confidence limits and 5000 bootstrap samples (Hayes, 2012).

2. Results

In a linear regression study of prognostic relationships between variables - evaluation of conditions of employee experience, employee engagement, organizational commitment, and intention to leave the organization - 7 statistically significant results were found. Regression analysis showed that the evaluation of employee experience conditions positively predicts employee engagement ($R^2 = 0.229$; $\beta = 0.479$, $p < 0.001$), affective commitment ($R^2 =$

0.298; $\beta = 0.546$, $p < 0.001$), normative commitment ($R^2 = 0.090$; $\beta = 0.300$; $p < 0.001$) and negatively predicts intention to leave the organization ($R^2 = 0.181$; $\beta = -0.425$, $p < 0.001$). Also, employee engagement ($R^2 = 0.286$; $\beta = -0.534$, $p < 0.001$), affective commitment ($R^2 = 0.276$; $\beta = -0.526$, $p < 0.001$), normative commitment ($R^2 = 0.061$; $\beta = -0.248$; $p = 0.0002$) negatively predicts intention to leave the organization.

The data analysis revealed a statistically insignificant relationship between employee experience conditions and continuance commitment ($\beta = -0.075$, $p = 0.276$) and between continuance commitment and intention to leave the organization ($\beta = -0.034$, $p = 0.625$). Insignificant links means that the prognostic relationship between the variables also does not exist and continuance commitment can not act as a mediator.

The mediator analysis showed 2 statistically significant and 2 statistically insignificant links. Mediator analysis indicated 2 statistically significant partial mediation: 1) the relationship between evaluation of employee experience conditions and intention to leave the organization is partially mediated by employee engagement ($R^2 = 0,323$; $F(2,212) = 50,483$; $p < 0,001$), the direct effect of evaluation of employee experience conditions affects 52%, and the engagement indirectly affects the intention of 48% to leave the organization; 2) the relationship between evaluation of employee experience conditions and intention to leave the organization is partially mediated by affective commitment ($R^2 = 0,323$; $F(2,212) = 46,155$; $p < 0,001$), the direct effect of evaluation of employee experience conditions affects 46%, and the affective commitment indirectly affects 54% of the intention to leave the organization. Based on Bootstrap confidence interval values for mediator analysis $[-0.2830; 0.0025]$, it was found that the normative commitment do not mediate the connection between the evaluation of employee experience conditions and the intention to leave the organization.

Moderator analysis showed 1 statistically significant and 3 statistically insignificant links. The evaluation of employee experience as a moderator do not strengthen the relation between: 1) employee affective commitment and intention to leave the organization ($p = 0,336$); 2) employee continuance commitment and intention to leave the organization ($p = 0,958$); 3) employee normative commitment and intention to leave the organization ($p = 0,540$). The moderator analysis found that the evaluation of employee experience conditions statistically significantly moderated the link between employee engagement and intention to leave the organization (R^2 change = 0.015, $F = 4,827$, $p = 0.029$). To extend, positive employee experience conditions reinforce negative employee engagement and intention to leave the organization relation.

Conclusions

In this research, the conditions of employee experience are studied for the first time in Lithuania, therefore obtained results have both scientific and practical significance. The study found that evaluation of employee experience conditions positively predicts employee engagement, affective commitment, and normative commitment, while evaluation of employee experience conditions, employee engagement, affective commitment, and normative commitment negatively predict intention to leave the organization. Moreover, 2 statistically significant partial mediation relationships have been identified – employee engagement and affective commitment is an intermediate factor through which the evaluation of employee experience conditions is related to the intention to leave the organization.

Finally, it was found that the evaluation of employee experience conditions acts as a statistically significant moderator and strengthens the negative relationship between employee engagement and the intention to leave the organization.

It is noted that the restricted sample size, convenience sampling, unequal distribution of respondents by demographic (gender, age) characteristics, socially desirable responding and COVID-19 pandemic and changed working conditions context might have impacted the comparability and generalisability of the findings. Therefore, it is recommended to replicate this study with a larger sample size using probability sampling in post-COVID era.

Due to the impact of scientific novelty and limited research of employee experience, there should be further academic research examining links between employee experience conditions and other organizational behavior such as employee empowerment, employee well-being. In further studies it is recommended to perform longitudinal or experimental research strategies in order to evaluate the dynamics of the variables and the causal relationships between them. Moreover, given the positive impact of employee experience conditions, practitioners should consider it as a way to tackle human resource challenges.

References

1. Alshathry, S., Clarke, M., Goodman, S. (2017). The role of employer brand equity in employee attraction and retention: a unified framework. *International Journal of Organizational Analysis*, 25(3), 413–431. doi:10.1108/IJOA-05-2016-1025
2. Auriemmo, A., Islam, S., Auriemmo, J., Mazzola, J. (2018). Employer and customer branding: an essential linkage leveraged through social media. *Journal of Management and Innovation*, 4(1), 1–25.
3. Bersin, J. (2017). The employee experience: culture, engagement, and beyond. *Global Human Capital Trend Report*, 51–61.
4. Durai, T., Ramakrishnan, M., King, R. (2018). Human-centric design thinking to boost employee experience in lean start-ups—an empirical study. *Journal of Emerging Technologies and Innovative Research*, 5, 575–588.
5. Foresee (2014). *Measuring employee experience to drive positive employee engagement* (white paper).
6. Hayes, A. F. (2012). PROCESS: A versatile computational tool for observed variable mediation, moderation, and conditional process modeling.
7. IBM & Globoforce. (2017). The employee experience index around the globe. How countries measure up and create human workplaces. Available at: <http://www.globoforce.com/wp-content/uploads/2017/09/The-Employee-Experience-Index-Around-the-Globe.pdf>
8. Jalaja, V., Padashetty, S. (2018). Employee experience in building employee engagement: An employee perspective. *International Journal of Research in Economics and Social Sciences*, 8(3), 17–28.
9. Kihlström, G. (2020). *Activator Brand Experience Maturity Model*. Cravety white paper. Available at: <https://www.cravety.com/activator-experience-maturity-model>
10. Mascarenhas B.G. (2019). Employer branding, employee value proposition, and employee experience: new approaches for people management in organizations. In: Thornton G., Mansi V., Carramenha B., Cappellano T. (eds) *Strategic Employee Communication*. Palgrave Macmillan, Cham. https://doi.org/10.1007/978-3-319-97894-9_8
11. Maylett, T., Wride, M. (2017). *The employee experience: How to attract talent, retain top performers, and drive results*. John Wiley & Sons.
12. Meyer, J. P., Stanley, L. J., Parfyonova, N. M. (2012). Employee commitment in context: The nature and implication of commitment profiles. *Journal of Vocational Behavior*, 80(1), 1–16. doi: 10.1016/j.jvb.2011.07.002
13. Morgan, J. (2017). *The employee experience advantage: How to win the war for talent by giving employees the workspaces they want, the tools they need, and a culture they can celebrate*. John Wiley & Sons.

14. Morgan, J. (2018). The technological environment in employee experience. *Leader to Leader*, 2018(87), 28–35. doi: 10.1002/ltl.20340
15. Pandey A., Gupta S. (2020). Defining employee experience as an antecedent indicator for employee productivity. *International Journal of Research in Engineering, Science and Management*, 3(5), 72–77.
16. Plaskoff, J. (2017). Employee experience: the new human resource management approach. *Strategic HR Review*, 16(3), 136–141. doi: 10.1108/SHR-12-2016-0108
17. Schaufeli, W. B., Bakker, A. B. (2003b). *Utrecht Work Engagement Scale (UWES-9)*. Available at: <https://www.wilmarschaufeli.nl/tests/>
18. Schaufeli, W. B., Bakker, A. B. (2003a). *Utrecht work engagement scale: Preliminary manual*. Occupational Health Psychology Unit, Utrecht University, Utrecht, 26(1), 64–100.
19. Shenoy, V., Uchil, R. (2018). Influence of cultural environment factors in creating employee experience and its impact on employee engagement: an employee perspective. *International Journal of Business Insights & Transformation*, 11(2).
20. Tett, R. P., Meyer, J. P. (1993). Job satisfaction, organizational commitment, turnover intention, and turnover: path analyses based on meta-analytic findings. *Personnel Psychology*, 46(2), 259–293. doi: 10.1111/j.1744-6570.1993.tb00874

Analysis of Business Performance Evaluation Practice at Manufacturing Sector in Latvia

Inta Kotane

Rezekne Academy of Technologies, Latvia
E-mail: Inta.kotane@rta.lv
ORCID iD: 0000-0002-9924-1394

Iveta Mietule

Rezekne Academy of Technologies, Latvia
E-mail: iveta.mietule@rta.lv
ORCID iD: 0000-0001-7662-9866

Keywords: performance, manufacturing, financial indicators, evaluation.

JEL code: G30, L25.

Introduction

Business performance measurement has become a separate area of research (Endrikat, Guenther, Titus, 2020), and interest in developing innovative and strategic performance measurement systems has increased in recent decades (Asiaei, et al., 2021). The authors believe that despite the growing number of publications on the topic, there is no consensus among researchers on the performance indicators of companies, their measurement and evaluation methods.

Manufacturing plays an important role in promoting Latvia's economic growth and is one of the largest sectors of the Latvian economy, accounting for 12.1% of the total value added structure in January-September 2020 (the second largest sector after trade with a share of 15.9%) (Ministry of Economics, 2020).

The aim of the research is to carry out an analysis of the performance evaluation practice of manufacturing companies in Latvia.

Research tasks:

1. To study the theoretical aspects of performance measurement and evaluation and the financial indicators used in the performance evaluation of Latvian companies;
2. To identify the opinion of experts on the significance of financial indicators used in financial analysis in assessing the performance of manufacturing companies;
3. To assess the closeness and impact of the relationship between manufacturing financial ratios and business performance indicators.
4. To develop conclusions and proposals.

The object of the research – the financial indicators used in the evaluation of the performance of manufacturing companies.

Novelty of the research – the significance of the financial indicators used in the financial analysis in the evaluation of the performance of manufacturing companies and the closeness of relationships between the financial indicators of the manufacturing industry and business indicators in Latvia have been assessed.

The study is based on the analysis of special literature and scientific publications, the evaluation of financial ratios used in Latvian institutions for financial analysis of companies, and the results of the expert survey (2021). Research period: 2010-2019.

In the research, general scientific research methods were applied: information analysis and synthesis, logical-constructive, monographic, correlation, and regression methods, expert survey method, data grouping and graphical representation methods.

1. Theoretical aspects of performance measurement and evaluation

Business performance of firms has, broadly, two parts – financial performance and non-financial performance (Seo, Lee, 2019). Performance measurement, which include both financial and non-financial measurements, encourage managers and employees to achieve both financial and non-financial goals and strike a balance between long-term and short-term interests (Kang, Fredin, 2012). To investors, financial analysts, auditors, and management, financial measurements provide information that is easier to understand (Upadhaya, et al., 2014), clear accounting, and financial ratios that can be easily calculated from the financial statements (Nastasia, Mironeasa, 2016).

The authors believe that in order to identify and evaluate the significance and role of financial indicators, to successfully solve the problems of corporate financial management, the issue of developing a unified system of financial indicators in the context of corporate performance evaluation becomes relevant.

2. Performance measurement and evaluation practice

In Latvia, information on corporate finances of companies can be found in databases of three institutions: Latvian Official Statistics Portal, “Lursoft” Ltd and CrediWeb portal. All three institutions use the same three financial indicators in the financial analysis of companies: total liquidity, financial dependency/ independence ratio, and return on assets.

In the course of the research, a survey of experts was conducted, 5 industry experts were interviewed to assess the significance of financial ratios used in financial analysis to evaluate the performance of manufacturing companies and to rank them according to significance on a scale from 1 (the most important ratio, or priority No.1) to 14 (the least significant indicator, or priority No.14.). An assessment of the closeness of correlations between the financial indicators of the manufacturing industry and business indicators in Latvia was performed.

Conclusions

1. The evaluation of the performance of companies in Latvia can be performed using only financial indicators. In Latvia, information on corporate finance of companies can be found in databases of three institutions that use the same three financial indicators in corporate financial analysis: total liquidity, financial dependency / independence ratio and return on assets.
2. In the survey, the experts unanimously acknowledged the following financial ratios as the most important in assessing the performance of manufacturing companies: return

on sales (ROS), return on equity (ROE), return on gross profit, receivables turnover in days and inventory turnover in days.

3. As a result of the correlation, it was found that there is a close or very close, statistically significant correlation between several financial indicators of the manufacturing industry and business indicators.
4. In order to identify and evaluate the significance and role of financial indicators, to successfully solve the problems of financial management of companies, it is necessary to develop a unified system of financial indicators for evaluating the performance of companies.

References

1. Asiaei, K., Rezaee, Z., Bontis, N., Barani, O., Sapiei, N.S. (2021). Knowledge assets, capabilities and performance measurement systems: a resource orchestration theory approach. *Journal of Knowledge Management*. <https://doi.org/10.1108/JKM-09-2020-0721>
2. Endrikat, J., Guenther, T.W., Titus, R. (2020). Consequences of strategic performance measurement systems: a meta-analytic review. *Journal of Management Accounting Research*, 32(1), 103–136. <https://doi.org/10.2308/jmar-52575>
3. Kang, G. G., Fredin, A. (2012). The balanced scorecard: the effects of feedback on performance evaluation. *Management Research Review*, 35(7), 637–661. <https://doi.org/10.1108/01409171211238848>
4. Ministry of Economics (2020). *Economic development of Latvia*. Available on: <https://www.em.gov.lv/en/media/4499/download>
5. Nastasiea, M., Mironeasa, C. (2016). Key performance indicators in small and medium sized enterprises. In *TEHNOMUS Conference Proceedings. New technologies and products in machine manufacturing technologies*, 46–53.
6. Seo, Y.W., Lee, Y.H. (2019). Effects of internal and external factors on business performance of startups in South Korea: the engine of new market dynamics. *International Journal of Engineering Business Management*, 11(4), 1–12. DOI: 10.1177/1847979018824231
7. Upadhaya, B., Munir, R., Blount, Y. (2014). Association between performance measurement systems and organisational effectiveness. *International Journal of Operations & Production Management*, 34(7), 853–875. <https://doi.org/10.1108/IJOPM-02-2013-0091>

The Impact of the COVID-19 on the Stock Market: Case of Italy

Julius Kviklis

Vilnius University, Lithuania

E-mail: Julius.kviklis@evaf.stud.vu.lt

ORCID iD: <https://orcid.org/0000-0003-3238-5729>

Keywords: COVID-19 pandemic; stock market; stock index; market volatility.

JEL code: G10, N24, D81.

Introduction

According to World Economic Forum (2020) released information regarding COVID-19 predictions, organization stated that “Globally, the corona virus shock is severe even compared to the Great Financial Crisis in 2007–08”. Various International Monetary organizations and funds stated that COVID-19 pandemic will have serious impact on global economy and financial markets.

Literature analysis disclose clear evidence that COVID-19 virus, had a major impact on the financial markets all around the world. On March 12 was stated that “It was a historic day on Wall Street. The Dow plunged 10% for its worst day since Black Monday in 1987. The 30-stock index fell 2,352 points — its largest point drop on record. Meanwhile the S&P 500 plunged 9% to close in bear market territory, thus officially ending the bull market that began in 2009 during the throes of the financial crisis.” (Pippa, Fitzgerald, & Imbert, 2020). The Dow and S&P from United States of America confirmed and backed up the rumors that “The Dow Jones, and S&P both of which take into account the share prices of a variety of companies in the US have dropped by over 20%”. (The Wall Street Journal, 2020) Couple days later S&P Global reported that, “It’s now clear that the hit to global economic activity from the measures to slow the spread of the corona virus pandemic will be massive”. (S&P Global Report, 2020). Nuhu Sansa and Ali Hasan, investigated if there was an impact of the COVID-19 on the Financial Markets in the USA within the period of 1st of March 2020 to 25th of March 2020. Study applied the Simple regression in Double Log and Semi log linear models and New York Dow Jones stock exchange was used as a sample. The study regression results revealed that there was a “positive correlation between the COVID-19 confirmed cases and USA – New York Dow Jones Financial Stock Market from 1st March 2020 to 25th March 2020 in USA. The coefficient for the COVID - 19 Confirmed cases is 2.64% which means that for each additional for the COVID - 19 Confirmed cases the USA - New York Dow Jones Financial Stock Markets was impacted for the same amount as well”

1. Methodology

Seeking to achieve the main purpose of this research, i.e. to assess the impact of the COVID-19 pandemic on the European stock markets, the stock market of Italy selected for fur-

ther research. Research aims to evaluate the impact of the COVID-19 pandemic on Italy (FTSE MIB 40) and stock exchange index during the three separate periods: The first period is dated from 1st of March, 2020 to 31st of May, 2020 and is selected to represent the beginning or so-called first wave of the spread of the COVID-19 pandemic. The second period is dated from 1st of June, 2020 to 31st of August, 2020 and is selected to represent the so-called recovery period. And finally, the third period is dated from 1st of September, 2020 to 30th of November, 2020 and is selected to represent the second wave of the spread of the COVID-19 pandemic. In order to reach the aim of this research, according to the analysis of previous efforts in the field, the regression approach is employed. In similar researches (for example, Sansa & Hasan (2020); Klose & Tillman (2020); and others) the simple regression models are used. Thus, in our research, the method of simple OLS (bivariate) regression is chosen as it can efficiently examine the relationship between stock indices and COVID-19 confirmed cases. A simple regression model allows to describe how strong the relationship is between two variables by fitting a line to the observed data, moreover, it provides an estimation of how a dependent variable change as the independent variable changes at the same time. Taking this into account, simple OLS (bivariate) regression models are created for each period and each country.

The following equation is implied in order to analyze the impact of the spread of the COVID-19 pandemic on the Italy stock markets and test the hypothesis:

$$Y_t = \alpha_0 + \beta_1 X_t + \varepsilon_t \quad (1)$$

Where: Y_t corresponds to the dependent variable, X_t – independent variable, a – coefficient, t – time, and ε – error term.

In order to reach the main aim of the research, the number of confirmed cases of COVID-19 infection (daily) is selected as an independent variable showing the spread of the COVID-19 pandemic. The independent variable was selected following recommendations and findings of others. As dependent variable, the FTSE MIB 40 index (Milano Indice di Borsa) was selected as representing the Italian stock market.

2. Results

During the first period of March to May FTSE MIB 40 displayed a high volatility according to the descriptive statistics of model variable, moreover the median was the lowest and had negative coefficients.

During the second period of June to August everything stabilized, the volatility greatly decreased by more than three times. Therefore, the decrease in standard deviation displayed a sign of low volatility which indicates that the index stabilized. Increase in median and is also a positive factor for financial recovery. Nevertheless, the linear regression model provided higher probability, thus FTSE MIB 40 for second period was insignificant, however taking into account the public available research, index improvements and reduction in the COVID-19 cases, and it is possible to conclude that from June to August the recovery period took place. Probably the most important in the research was to analyze how Italy regarding the financial markets were prepared for the upcoming third period from September to November, because according to available data the presumptions of upcoming

second COVID-19 pandemic wave developed. The highest confirmed cases in Italy were during the second pandemic wave. Yet, the gross domestic product growth rate greatly increased, the standard deviation indicator also raised, but not as much as in the first wave period. The preparations for the second wave are successful, because as it is provided in the model the largest and most liquid Italy stock index display better performances than before. Medians and coefficients increased in comparison with the 1st period, even though the confirmed cases raised. The effective strategies of virus testing's, mobile hospital instalment and successful regional lockdowns positively affected Italy's financial market, as a result the greater performance of index is displayed.

Table 1. Descriptive statistics of model variable for FTSE MIB 40

	1st Period		2nd Period		3th Period	
	CASESITALY	FTSEMIB40	CASESITALY	FTSEMIB40	CASESITALY	FTSEMIB40
Mean	2440.339	17381.8	376.4697	19764.36	14215.66	19824.86
Median	2173.500	17198.28	280	19804.31	8803.000	19558.69
Maximum	6203.000	21946.03	1460.000	20723.42	40902.00	22352.46
Minimum	300.0000	14894.44	-148.000	18523.71	975.0000	17872.28
Std. Dev.	1713.125	1469.406	314.5741	456.8712	13492.86	1117.411
Skweness	0.509090	1.553032	1.915795	-0.307149	0.502783	0.783920
Kurtosis	2.084999	6.180629	6.510566	2.982744	1.674539	2.870417
Jarque-Bera	4.840955	51.05708	74.26419	1.038563	7.496692	6.702894
Probability	0.088879	0.000000	0.000000	0.594948	0.023557	0.035034
Sum	151301.00	1077671	24847.00	1304448	924018.0	1288616
Sum Sq. Dev.	1.79E+08	1.32E+08	6.43E+06	1.36E+07	1.17E+10	7.99E+07
Observations	62	62	66	66	65	65

Conclusion

The study examined the FTSE MIB 40 index affection by Italy's new confirmed COVID-19 cases during three specific periods. The descriptive statistics supported the selection in such order: 1st period was selected as a first pandemic wave time frame, later on lower and stable new confirmed cases rate 2nd period from June to August was selected as recovery stage and the 3rd period shows an inclination in new confirmed cases growth, accordingly to the given circumstances it was selected as a second wave stage from September to November. The separation of the periods enhanced the research with the possibility to create a comparison between them. In the case of Italy study demonstrated that during the first period FTSE MIB 40 index had a high volatility (highest from all three periods) with the negative coefficient and lowest median. As for the second period index volatility decreased more than two times and it indicates that the financial market stabilized. Italy's coefficient moved from negative to positive and median increased. The third period analysis displayed greater results in comparison with first period and this is important to emphasize the results, such

increase proves that governmental decisions and strategies during the 2nd recovery period, had a positive effect on the financial markets and country were better prepared for the second COVID-19 virus wave. Nevertheless, in all three periods the impact of COVID-19 pandemic to Italy's financial index market is evident.

References:

1. Klose, J., Tillman, P. (2020). *COVID-19 and Financial Markets: A Panel Analysis for European Countries*. MAGKS Papers on Economics 202025, Philipps-Universität Marburg.
2. Sansa, N., Hasan, A. (2020). *The Impact of the COVID -19 on the Financial Markets: Evidence from China and USA*.
3. Stevens, P., Fitzgerald, M., Imbert, F. (2020). *Stock market live Thursday: Dow tanks 2,300 in worst day since Black Monday, S&P 500 bear market*. Available at: <https://www.cnn.com/2020/03/12/stock-market-today-live.html>
4. S&P Global (2020). *Coronavirus: Economic & Credit Market Implications*. Available at: <https://www.spglobal.com/en/research-insights/featured/economic-implications-of-coronavirus>
5. The Wall Street Journal. (2020) *Dow Jones Industrial Average*. Available at: <https://www.wsj.com/market-data/quotes/index/US/DJIA>

Application of Qualitative Characteristics to Evaluate Misstatements in Financial Statements: Evidence from Factual Audit Data

Audrius Masiulevičius

Vilnius University, Lithuania

E-mail: audrius.masiulevicius@evaf.vu.lt

ORCID iD: <https://orcid.org/0000-0002-2222-0149>

Vaclovas Lakis

Vilnius University, Lithuania

E-mail: vaclovas.lakis@ef.vu.lt

ORCID iD: <https://orcid.org/0000-0003-0142-9573>

Keyword. qualitative characteristics, audit, misstatement, financial statements, users.

JEL code: M42, M41.

Introduction

The scientific literature notes that it is important to understand how auditors apply qualitative characteristics (which describe the essence of misstatement) in real audits, especially when even immaterial errors may be important to investors due to qualitative characteristics (Choudhary et. al., 2021). Most of the theoretical research so far relied on surveys or experiments, but there is little factual data on how auditors behave during real audits (rather than simulations). *The aim of the research* is to examine the factual application of primary qualitative characteristics in assessing identified misstatements in the financial statements. *Object of the research:* during the research the audits performed in one Lithuanian audit company for the financial year 2020 were examined. *The research method* used in the study is based on the analysis of historical data (observation of the past). The research process is divided into two stages. In the first stage, the main (primary) and secondary qualitative characteristics are identified. In the second stage, an analysis is made whether the main (primary) qualitative characteristics are being applied by the auditors during actual audits.

1. Literature review on the application of qualitative characteristics

The initial considerations of qualitative characteristics in literature began around 1970 (Span et. al., 2010; Fang, Jacobs, 2010; Wahdan, Hassan, 2019). Nevertheless, more detailed research performed by Ng, Tan (2007), Choudhary et al. (2016) or Eilifsen, Messier (2015) are more recent. The repeated results by various researchers highlighted the fundamental problem - *auditors prefer quantitative misstatement characteristics and qualitative characteristics are not sufficiently appreciated* (Acito et. al., 2019; DeZoort et. al., 2019; Commerford et. al. 2018; Emby, Pecchiari, 2013; Green, Cheng, 2019; Legoria et. al., 2013; McKee, Eilifsen, 2000; Ng, Tan, 2007). What is more, most of the studies were based on experiments,

analysis of publicly available limited data, surveys, or simulations, but not factual audit data. Eilifsen, Messier (2015) even point out that the main limiting factor of their study is the lack of factual data. Currently, there is an open gap between the theoretical knowledge on application of qualitative characteristics and what is actually done by auditors.

2. Dividing qualitative characteristics into primary and secondary

Most of the researchers, examining qualitative characteristics, refer to the examples provided in the practical literature (Ng, Tan, 2007; Corte et. al., 2010; Manita et. al., 2011; Cacho et. al., 2012; Legoria et. al., 2013; Emby, Pecchiari, 2013; Eilifsen, Messier, 2015; Kristensen, 2015; Choudhary et. al., 2016; DeZoort et. al., 2019; Acito et. al., 2019; David, Abeysekera, 2021), therefore the professional audit literature could be used as a primary source of information for identifying qualitative characteristics. After reviewing the professional and scientific literature, six (SAB 99, 1999; AS 2810, 2017; ISA 450, 2009; ISAE 3000, 2015; SAS 122, 2012; SAS 107, 2006) main sources of information were identified, providing detailed examples of qualitative characteristics. By comparing and grouping the qualitative characteristics presented in the above documents, *five main groups of qualitative characteristics were distinguished*: (1) financial; (2) requirements; (3) persona related; (4) disclosure; and (5) general. Financial position or/and profitability are key for investors (Sederavičiūtė, 2020; Bistrova, Lace, 2012; Blajer-Golebiewska, Kos, 2016; Betti, Consolandi, 2018) therefore, the financial characteristics, that reveal the change in the trends of the company's financial data, can be singled out as the main (primary) ones.

3. Research results

Not material (by auditors' consideration) misstatements (meaning they were not corrected in financial statements) were found in nine audits (out of all audits performed by one audit company for 2020 financial year). These are misstatements that indicate that there are misstatements of a quantitative and / or qualitative nature, but in the auditor's professional judgment they do not affect users of the financial statements and are therefore not corrected in the financial statements (see table 1).

Table 1. A depersonalized summary of data obtained for the study.

No.	Revenue	Uncorrected financial statement misstatements	Misstatements relate to qualitative characteristics	Primary characteristics breached
Company 1	4 000 001 - 20 000 000 EUR	Yes	Yes	Yes
Company 2	4 000 001 - 20 000 000 EUR	Yes	Yes	Yes
Company 3	0 - 350 000 EUR	Yes	Yes	No
Company 4	4 000 001 - 20 000 000 EUR	Yes	No	N/A
Company 5	4 000 001 - 20 000 000 EUR	Yes	No	N/A
Company 6	4 000 001 - 20 000 000 EUR	Yes	No	N/A
Company 7	350 001 - 4 000 000 EUR	Yes	No	N/A
Company 8	350 001 - 4 000 000 EUR	Yes	No	N/A
Company 9	350 001 - 4 000 000 EUR	Yes	No	N/A

Source: Compiled by the authors based on data provided by the audit company

All unaccounted-for audit misstatements were compared with the three main financial qualitative characteristics (primary ones). In most cases (table 1, Companies No. 4-9) only quantitative violations were detected. Misstatements of the remaining companies (Companies No. 1-3) were related to the qualitative characteristics, but the qualitative misstatement of Company No. 3 was not related to the primary financial qualitative characteristics. The data revealed that the qualitative misstatements identified in companies No. 1-2 (table 1) were related to primary qualitative characteristics

We inquired audit company whether these misstatements should be accounted as material, especially when they relate to primary qualitative characteristics. The audit firm commented that, although the qualitative characteristics were identified, a professional decision was made after a thorough analysis that the misstatements were not material and would not change the economic decisions made by users of the financial statements. Audit company did not provide more detailed information on the auditor's additional considerations, so for this research it was not possible to assess the correctness of the decisions made by the auditors.

The data obtained for the research were limited due to confidentiality, therefore we could not perform a more detailed analysis or identify and analyze the reasons that led to such professional decisions of the audit firm's employees. It cannot be said that the auditors made erroneous professional decisions (although there is such a risk), but it can be concluded that there are qualitative characteristics that auditors do not follow blindly. The results we got based on factual audit data confirm theoretical research, that auditors do not thoroughly comply to all the qualitative characteristics. Requiring mandatory application of primary qualitative characteristics, would be one way to alleviate the current problem of insufficient application of qualitative characteristics.

Conclusions and recommendations

After grouping the qualitative characteristics, five main groups of qualitative characteristics were distinguished: (1) financial; (2) requirements; (3) persona; (4) disclosure; and (5) general. Three financial characteristics that reveal the change in the trends of the company's financial data are singled out as the main (primary) ones: (1) the misstatement leads to the achievement of the set expectations; (2) the misstatement changes the trends in the financial data and (3) the misstatement changes the loss-making activities of the enterprise into a profitable one or vice versa. A study of factual audits on the application of primary qualitative characteristics revealed that auditors do not apply these characteristics in all cases. The primary qualitative characteristics should be mandatory. This could ensure the application of these characteristics and eliminate the risk of an auditor's professional misconduct.

References

1. Acito, A. A., Burks, J. J., Johnson, W.B. (2019). The materiality of accounting errors: evidence from SEC Comment Letters. *Contemporary Accounting Research*, 36(2), 839–868. <https://doi.org/10.1111/1911-3846.12458>
2. *AS 2810: Evaluating Audit Results* (2010). Public Company Accounting Oversight Board (PCAOB).

3. Asare, K. S., Buuren, van P. J., Majoor, B. (2019). The joint role of auditors' and auditees' incentives and disincentives in the resolution of detected misstatements. *Auditing: A Journal of Practice & Theory*, 38(1), 29–50. <https://doi.org/10.2308/ajpt-52153>
4. Betti, G., Consolandi, C., Eccles, R. G. (2018). The relationship between investor materiality and the sustainable development goals. *Sustainability*, 10, 23. <https://doi.org/10.3390/su10072248>
5. Bistrova, J., Lace, N. (2012). Trade-off between investor's short and long-term goals. *Economics and Business*, 22, 23–29.
6. Blajer-Gołębiewska, A., Kos, M. (2016). Investors are more sensitive to information about financial rather than ethical reputation of a company: evidence from an experimental study. *Economics & Sociology*, 9(13), 11–22. <https://dx.doi.org/10.14254/2071-789X.2016/9-1/1>
7. Cacho, S., Ochoa, M., Ramirez, M. (2012). Qualitative perspective of audit materiality: empirical evidence in Mexico and Colombia. *Chinese Business Review*, 11(10), 864–872. DOI:10.17265/1537-1506/2012.10.003
8. Choudhary, P., Merkley, K., Schipper, K. (2016). Qualitative characteristics of financial reporting errors deemed immaterial by managers. *SSRN Electronic Journal*, 70. <http://dx.doi.org/10.2139/ssrn.2830676>
9. Choudhary, P., Merkley, K., Schipper, K. (2021). Immaterial error corrections and financial reporting reliability. *Contemporary Accounting Research*, Accepted, 59. <http://dx.doi.org/10.2139/ssrn.2830676>
10. Commerford, B. P., Hatfield, R. C., Houston, R. W. (2018). The effect of real earnings management on auditor scrutiny of management's other financial reporting decisions. *The Accounting Review*, 93(4), 145–163. <https://doi.org/10.2308/accr-52032>
11. Corte, J., Garcia, F., Laviada, A. (2010). Effective use of qualitative materiality factors: evidence from Spain. *Managerial Auditing Journal*, 25(5), 458–483. <https://doi.org/10.1108/02686901011041849>
12. David, R., Abeysekera, I. (2021). Auditor judgements after withdrawal of the materiality accounting standard in Australia. *Journal of Risk and Financial Management*, 14, 1–20. <https://doi.org/10.3390/jrfm14060268>
13. DeZoort, F. T., Holt, T. P., Stanley, J. D. (2019). A comparative analysis of investor and auditor materiality judgments. *Auditing: A Journal of Practice & Theory*, 38(3), 149–166. <https://doi.org/10.2308/ajpt-52318>
14. Eilifsen, A., Messier, W. F. Jr. (2015). Materiality guidance of the major public accounting firms. *Auditing: A Journal of Practice & Theory*, 34(2), p. 3–26. <https://doi.org/10.2308/ajpt-50882>
15. Emby, C., Pecchiari, N. (2013). An empirical investigation of the influence of qualitative Risk factors on Canadian auditors' determination of performance materiality. *Accounting Perspectives*, 12(4), 281–299. <https://doi.org/10.1111/1911-3838.12019>
16. Fang, K. C., Jacobs, B. (2000). Clarifying and protecting materiality standards in financial statements: A review of SEC Staff Accounting Bulletin 99. *The Business Lawyer*, 55(3), 1039–1064.
17. Green, W. J., Cheng, M. M. (2019). Materiality judgments in an integrated reporting setting: The effect of strategic relevance and strategy map. *Accounting, Organizations and Society*, 73, 1–14. <https://doi.org/10.1016/j.aos.2018.07.001>
18. *International Standard on Auditing (ISA) 450: Evaluation of Misstatements Identified During the Audit*. (2009). International Auditing and Assurance Standards Board (IAASB).
19. *ISAE 3000, Assurance Engagements Other than Audits or Reviews of Historical Financial Information*. (2009). International Auditing and Assurance Standards Board (IAASB).
20. Kristensen, R. H. (2015). Judgment in an auditor's materiality assessments. *Danish Journal of Management & Business*, 79(2), 53–65.
21. Legoria, J., Melendrez, K. D., Reynolds, J. K. (2013). Qualitative audit materiality and earnings management. *Review of Accounting Studies*, 18(2), 414–442. <https://doi.org/10.1007/s11142-012-9218-3>
22. Manita, R., Lahbari, H., Elommal, N. (2011). The impact of qualitative factors on ethical judgments of materiality: an experimental study with auditors. *International Journal of Business*, 16(3), 231–243.
23. Mckee, T. E., Eilifsen, A. (2000). Current materiality guidance for auditors. *CPA Journal*, 70(7), 54–58.
24. Ng, T. B. P., Tan, H. T. (2007). Effects of qualitative factor salience, expressed client concern, and qualitative materiality thresholds on auditors' audit adjustment decisions. *Contemporary Accounting Research*, 24(4), 1171–1192. <https://doi.org/10.1506/car.24.4.5>

25. SAS 107 (AU Section 312): *Audit Risk and Materiality in Conducting an Audit*. (2006). American Institute of Certified Public Accountants (AICPA).
26. SAS 122 (AU-C Section 320): *Materiality in Planning and Performing an Audit*. (2012). American Institute of Certified Public Accountants (AICPA).
27. *SEC Staff Accounting Bulletin (SAB): No. 99 – Materiality* (1999). Securities and exchange commission (SEC).
28. Sederavičiūtė, Ž. (2020). KPI rodikliai – alternatyva įmonių finansinės veiklos vertinimui. *Science and Studies of Accounting and Finance: Problems and Perspectives*, 14 (1), 58–66. <https://doi.org/10.15544/ssaf.2020.06>
29. Span, G., Popa, I., Timea, F., Atanasiu, P. (2010). The background of professional judgment of materiality in statutory audit based on qualitative factors analysis. *Annals of Faculty of Economics, University of Oradea, Faculty of Economics*, 1, 585–588.
30. Wahdan, M. A., Hassan, M. (2019). Automatic assessment of materiality: a knowledge-based approach. *International Journal of Computer Auditing*, 1(1), 64–91.

Research on the Awareness and Application of Strategic Management Accounting Instruments in Lithuanian Companies

Kamilė Medeckytė

Vilnius University, Lithuania
E-mail: kamile.medeckyte@evaf.stud.vu.lt

Daiva Tamulevičienė

Vilnius University, Lithuania
E-mail: daiva.tamuleviciene@evaf.vu.lt
ORCID iD: <https://orcid.org/0000-0002-0187-037X>

Keywords: strategic management accounting, strategic management accounting instruments, Lithuanian enterprises.

JEL code: M40.

Introduction

In recent decades, as the business environment undergone rapid changes due to increasing globalization of companies, growing need for economic knowledge and rapidly evolving technologies, the main goal of modern organizations has become the pursuit of adapting their knowledge, experience and available business opportunities to the changing needs of the market.

This uncertain and changing business situation has become a precondition for the emergence of a new direction of management accounting – strategic management accounting. Strategic management accounting instruments help organisations monitor the success of strategic goals by providing information on customer and competitor strategies, product markets, cost structure, and other information that influences long-term strategic decisions (Noordin, Zainuddin, Tayles, 2009; Shah, Malik, Malik, 2011).

As the strategic management accounting instruments are not widespread in Lithuanian enterprises and there is hardly any detailed research on their application, an empirical study was conducted to determine the current level of awareness and application of strategic management accounting instruments in Lithuanian companies. In order to assess the experience of awareness and application of strategic management accounting instruments in Lithuanian companies, a survey of the companies' managers, accountants and financiers was carried out using the method of the questionnaire online survey data collection. Study population – companies operating in Lithuania. A sample survey of 96 companies with an error of 10% was identified. Convenience sampling and “snowball” methods considered as a type of non-probability sampling were chosen for the survey. 103 companies participated in the survey. The questionnaire of the survey consisted of two groups of questions: the questions in the 1st group were dedicated to identifying the size of companies, the period of existence in the market, the type of activity. The questions of the 2nd group were designed

to implement two tasks of the study: 1) to determine the level of awareness and application of strategic management accounting instruments in Lithuanian companies; 2) to disclose the reasons why companies refuse to implement these instruments.

1. Analysis of the level of awareness and application area of strategic management accounting instruments in Lithuanian companies

The scientific literature provides a wide variety of strategic management accounting instruments. Cadez, Guilding (2007; 2008) systematized the instruments presented by various authors by grouping them into five categories (see Figure 1).

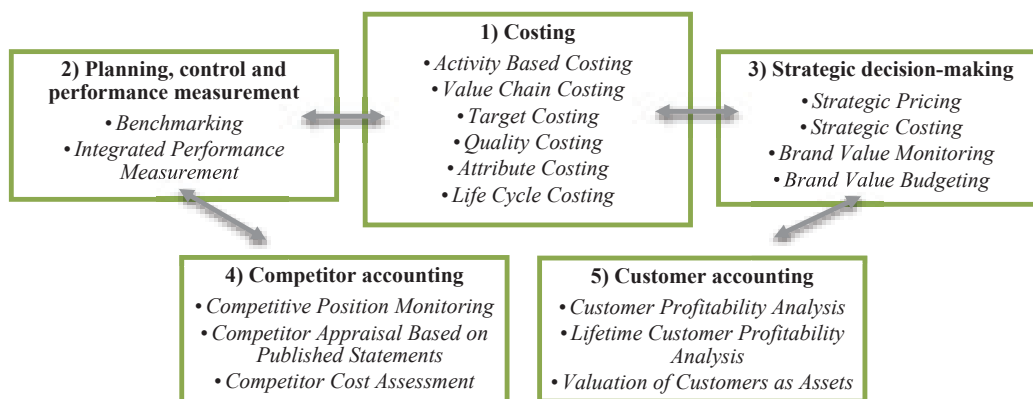

Figure 1. Structure of strategic management accounting instruments categories

Source: compiled by authors based on Cadez, Guilding, 2007; 2008

The questionnaire about the level of awareness and application of strategic management accounting instruments in Lithuanian companies was ranked sequentially according to the five categories of strategic management accounting instruments identified by Cadez, Guilding (2008). The scientific research began from the question of the level of awareness and application of the first category of strategic management accounting instruments, that include *costing instruments*, in Lithuanian companies. The results of the study have shown that 35% of respondents, i.e., 36 out of 103 companies surveyed are aware of and use an Activity-Based Costing instrument. Meanwhile, Life Cycle costing is the least known and used in the business process costing instrument.

Another question in the survey was related to the category of *planning, control and performance measurement instruments*. The replies of respondents about the popularity of Benchmarking and instrument of Integrated Performance Measurement attributed to this group are unevenly distributed: the Benchmarking is better known and more common if compared to the Integrated Performance Measurement of the companies: The Integrated Performance Measurement is known and applied only in more than a fifth of the surveyed companies.

Another question aimed to find the level of awareness and application of instruments belonging to the category of *strategic decision-making* in Lithuanian enterprises. The results of the study revealed that the instruments of Strategic Pricing and Strategic Costing are the most well-known and widely used in practice or they are planned to be used in the future. The least surveyed companies use Brand Value Budgeting.

The level of awareness and application of *competitor accounting* group of instruments in Lithuanian organisations was further investigated. The instrument of Competitive Position Monitoring is the most well-known and widely used in practice. Competitor Appraisal Based on Published Statements is also rather popular. 37.8% of respondents currently use or plan to use this instrument in the future. It should be noted that Competitor Cost Assessment is not only rarely use but also hardly known. Nearly a third of respondents said the instrument was not known to them or they could not answer the question.

Customer accounting instruments are attributed to the last group of the researched strategic management accounting instruments. The results of the study revealed that the majority of respondents use Customer Profitability Analysis in their activity. This instrument is the most popular not only in the category of customer accounting instruments but also among all strategic management accounting instruments.

2. Reasons for the difficulties in implementing the strategic management accounting instruments in Lithuanian companies

To find out the reasons why companies experience difficulties in implementing strategic management accounting instruments, respondents were asked a particular question with a list of possible reasons. As the respondents indicated, the most significant reason for the difficulties in implementing strategic management accounting instruments is the lack of time required to implement the instruments. The statements “there are no competent staff to implement strategic management accounting instruments”, “management lacks knowledge of the benefits of strategic management accounting” and “in order to implement strategic management accounting instruments a lot of data needs to be collected but there is no specialised data recording technology” were also marked as significant reasons. The least significant reason indicated by respondents was the fact that the rapidly changing internal and external environment of the company could complicate the implementation and use of strategic management accounting instruments.

Conclusions

The results of the study have revealed strategic management accounting instruments are not sufficiently known and are rarely used in the activities of the companies as well as the general reasons leading to the difficulties in implementing these instruments. Further in-depth research in this area is needed to identify the detailed reasons for the difficulties in implementing individual strategic management accounting instruments. This would allow specific recommendations to be made to accelerate the development of less popular strategic management accounting instruments.

References

1. Cadez, S., Guilding, C. (2008). An exploratory investigation of an integrated contingency model of strategic management accounting. *Accounting, Organizations and Society*, 7–8(33), 836–863. <https://doi.org/10.1016/j.aos.2008.01.003>

2. Cadez, S., Guilding, C. (2007). Benchmarking the incidence of strategic management accounting in Slovenia. *Journal of Accounting & Organizational Change*, 2(3), 126–146. <https://doi.org/10.1108/18325910710756140>
3. Noordin, R., Zainuddin, Y., Tayles, M. (2009). Strategic management accounting information elements: Malaysian evidence. *Asia-Pacific Management Accounting Journal*, 1(4), 17–34.
4. Shah, H., Malik, A., Malik, M. S., (2011). Strategic management accounting – a messiah for management accounting? *Australian Journal of Business and Management Research*, 1(4), 1–7. <http://www.ajbmr.com/articlepdf/ajbmr01n0401.pdf>

Accountant's Professional Judgment: the Uncertainty and Risks

Svetlana Pankova

Orenburg State University, Russia

E-mail: panksv@mail.ru

ORCID iD: 0000-0002-3632-6702

Elena Satalkina

Orenburg State University, Russia

E-mail: elena.satalkina@mail.ru

ORCID iD: 0000-0002-9899-1046

Keywords: accountant's professional judgment, uncertainty, risk classification.

JEL code: M41, M14.

Introduction

The purpose of the research is to manage the risks arising in the work of an accountant when he applies professional judgment.

The object of the research is the accountant's professional judgment as a category of accounting methodology.

Objective of this research is to identify areas of uncertainty for the application of professional judgment, in accordance with IFRS and Russian accounting standards (RAS) and the risk factors identification of accountant's professional judgment influence and form the risk's classification. The research is conducted by monographic method. Empirical results are based on a survey of professional accountants who are improving their qualifications at Orenburg State University.

1. Research on uncertainty

The professional judgment is the most significant and actively investigated innovation in modern accounting. Its purpose, nature and place as accounting category are not defined in state regulative. Accountant's professional judgment is impossible without ethics. Therefore, we propose to consider an accountant's professional judgment as motivated, independent judgment of accountant or auditor based on specialized knowledge, professional experience and general accepted practice under regulative uncertainty adopted in compliance with professional ethics principles.

Professional accountants are dealing with the uncertainty caused by the social situation under IFRS constantly (Lantto, 2020). Professional judgment is necessary not only in the preparation of financial statements, but also in their interpretation (Hushko, Kulishov, Izmaylov, Subačienė, 2019; Bachtijeva, 2020; Jurkonienė, Stašaitytė, 2019).

The uncertainty arising with accountant's professional judgment, in our opinion, associated with: insufficiency of internal and external business information; business transactions; reporting information. However, the uncertainty increases because of unpredictable events possibility with its probability characteristics are unknown.

2. Classification of risks in making professional judgment of an accountant

It is necessary to consider the risks associated with professional judgment in order to make a decision under conditions of uncertainty. Based on the results of the focus group survey and research by scientists, we propose the following risk classification (table 1).

Table 1. Risks of accountant's professional judgment classification

Classification criteria	Professional judgment risks
factors of risk's nature	<ul style="list-style-type: none">• external• internal
risk's degree	<ul style="list-style-type: none">• high• average• low
risk's duration	<ul style="list-style-type: none">• long- term• short-term
risk's frequency	<ul style="list-style-type: none">• systematic• one time
risk's predictability	<ul style="list-style-type: none">• predictable• unpredictable
risk's flexibility	<ul style="list-style-type: none">• reduced• not reduced
areas of professional judgment	<ul style="list-style-type: none">• an accounting policies• an object of accounting• an accounting principles• quantitative reporting indicators• quality of financial reporting

Source: compiled by authors

Conclusions

As a result of the investigation we can conclude that any accountant's professional judgment are at risk, because of its uncertain nature. We propose to classify the accounting risks of professional judgment, by the following criteria: factors of risk's nature; risk's degree; risk's duration, risk's frequency, risk's predictability, risk's flexibility, areas of professional judgment.

References

1. Bachtijeva, D. (2020). Problematics of creative accounting and earnings management in the context of the development of accounting theories. *Buhalterinės apskaitos teorija ir praktika*, 22, 6. <https://doi.org/10.15388/batp.2020.28>
2. Hushko, S., Kulishov, V., Izmaylov, Y., Subačienė, R. (2019). Trends of forming the accounting and analytical management system in the digital economy. *Buhalterinės apskaitos teorija ir praktika*, 19, 6. <https://doi.org/10.15388/batp.2019.6>
3. Jurkonienė, G., Stašaitytė, J. (2019). Audit of financial reporting documents: analysis of process of determining materiality. *Buhalterinės apskaitos teorija ir praktika*, 20, 1. <https://doi.org/10.15388/batp.2019.9>
4. Lantto, A. M. (2020). Obtaining entity-specific information and dealing with uncertainty: financial accountants' response to their changing work of financial reporting and the role of boundary objects. *Critical Perspectives on Accounting*, 102277. <https://doi.org/10.1016/j.cpa.2020.102277>

Methodological Bases of Life Cycle Assessment of Textile Products Cleaning Technologies at the Cleaning Industry Enterprises

Olga Paraska

Khmelnyskyi National University, Ukraine
E-mail: olgaparaska@gmail.com
ORCID iD: 0000-0002-3803-0382

Tetiana Ivanishena

Khmelnyskyi National University, Ukraine
E-mail: itso77@ukr.net

Keywords: Life Cycle Assessment, textile cleaning processes, environmental impact.

JEL code: O14, O13, Q01.

Introduction

According to Life Cycle Assessment (LCA), detailed information was received at an enterprise about the technological processes and the impact of their individual factors on the environment and human health. Methodological bases of procedure introduction of estimation of life cycle of LCA textile products cleaning technologies at the cleaning industry enterprises were created and scientifically grounded. According to the integration of the general results, it is proved that the share introduced by the processes of textile products cleaning in the aquatic environment is insignificant in comparison with other technologies.

1. The implementation of the LCA method as one of the leading tools for sustainable business development

In modern conditions, the activity of the garment care industry involves finding opportunities to reduce costs, minimize risks, increase business stability and its competitive advantages (Greening the economy through..., 2012; Muthu, 2015).

According to Shen, et al. (2017), Lomonaco-Benzing, Ha-Brookshire, (2016) the implementation of the Life Cycle Assessment (LCA) method is one of the leading tools for sustainable business development, which allows to increase the efficiency of the enterprise activity by studying the environmental impact while exportation of textile products / services. The use of the LCA method is driven by the desire to increase the market value of products / services by disclosing information about their safety. In addition, the LCA allows you to set and optimize the most energy and resource intensive stages of technological processes, as well as to create the preconditions for cost reduction through the rational use of raw materials, resources and energy.

2. Methodology and results

The LCA method is a part of the integrated Life Cycle Sustainability Assessment method in accordance with ISO 14000 series standards, in particular ISO 14040: 2006 Environmental management – Life Cycle Assessment – Principles and framework, ISO 14044: 2006 Environmental management – Life Cycle Assessment – Requirements and guidelines. This method also includes Life Cycle Costing and Social Life Cycle Assessment (Environmental management, 2021; Life cycle assessment, 2021). The life cycle assessment is carried out in the following stages:

- development of inventory of all input materials (resources, energy) and outputs (waste, emissions, other environmental impacts);
- assessment of potential impacts on the basis of input data and results compiled in the inventory analysis;
- interpretation of results.

By categories of environmental impact of technological processes, there are: disturbance of the landscape; change, reduction of biodiversity; eutrophication as a result of P and N emission; global warming as a result of greenhouse gas emissions; ozone depletion during the emission of pollutants; acidification of the environment during the emission of acid pollution; air pollution; heavy metal pollution; photochemical smog; physical, including noise pollution, etc.

In the LCA study of the technological process of textile products cleaning in the aquatic environment at the company LLC TPP “Universal” (Ukraine) estimation techniques were used. Cleaning technologies for environmental and human health impacts, the effectiveness of the removal of contamination from textiles were analyzed (Mandziuk, et al., 2016).

An operational analysis of a textile cleaning service provider contains the following input and output indicators. Inputs: materials (chemicals, detergents, auxiliaries), water (drinking and technological); the amount of energy used; types of services. Outputs: clean textile products; detergent remains (waste); emission (evaporation) of washing solutions.

Types of effect, methods used and interpretation of results: vapors of chemicals emitted into the atmosphere, hydrosphere, water and affecting the environment, health of staff who remain in working space for a long time.

The characterization process involves the transformation of environmental variables into a single cost system. In practice, this is done by multiplying the variable, which is obtained in the inventory analysis by the coefficient of performance.

Normalization occurs after characterization. When normalized, the impact class indicators correlate with relevant data in a particular area; also calculate the relative share of the influence of the class of action in the ratio of the reference value. Normalization is required before the final consolidation of the data into a common impact indicator. At the accenting stage, the normalized values of the impact class indicators are combined into integrated impact indicators if the action of the system under study is to be expressed by means of integrated indicators. An integrated impact indicator can be obtained by multiplying the normalized impact class indicators by the weight factor of each impact class and compiling the results obtained. In practice, only mandatory structural parts that comply with the standard are performed at the LCA stage. The results are represented as the equivalents of CO₂ and SO₂.

Integrated indicators of the impact of the technological process of textile cleaning in the aquatic environment are given in Table 1.

Table 1. **Integrated indicators of the impact of the process of textile products cleaning**

Weight coefficient			Integrated Impact Indicators		
Local	Regional	Global	Local	Regional	Global
10.57	11.77	12.76	0.137	0.153	0.106
10.39	8.61	9.12	$3.3 \cdot 10^{-4}$	$2.7 \cdot 10^{-4}$	$2.9 \cdot 10^{-4}$
8.34	9.23	10.56	0.033	0.036	0.041
8.02	9.66	12.71	$1.6 \cdot 10^{-4}$	$1.9 \cdot 10^{-4}$	$2.5 \cdot 10^{-4}$
7.23	9.41	10.09	-	-	-
13.68	11.68	7.56	-	-	-
2.57	3.52	3.8	0.0016	0.002	0.002
14.91	11.23	8.92	-	-	-
Total					
75.71	75.11	75.52	0.172	0.19	0.149

Source: compiled by authors based on Environmental management, 2021.

The implementation of the LCA procedure allows us to determine the interaction between energy, material costs and technology over the life cycle of textiles, as well as in the long run – to determine the impact of these interactions on the environment and society (from raw materials production through processing, manufacturing, distribution, use, disposal or recycling).

Conclusions

1. The technological process of textile products cleaning from the point of view of the identified sources of environmental danger was analyzed, it was determined which stages of the technological process of the products cleaning have the negative impact on the environment and employees of the enterprise as well as the most harmful preparations.
2. According to the integration of the results of the study, the share of textile cleaning technologies in the aquatic environment is insignificant, which makes it possible to extend the scope of their use in the process of removing contaminants from the products, restoring their consumption properties, by creating closed water supply cycles and using new types of detergents compositions with low environmental impact.

References

1. *Environmental management*. ISO 14040: 2006. Environmental management – Life cycle assessment – Principles and framework. Available from: <https://www.iso.org/standard> [accessed 27 September 2021].
2. *Greening the economy through Life Cycle Thinking*. UNEP DTIE Sustainable Consumption and Production Branch. 2012. Paris.

3. *Life cycle assessment*. ISO 14044: 2006. Environmental management – Life cycle assessment – Requirements and guidelines. Available from: <https://www.iso.org/standard> [accessed 27 September 2021].
4. Lomonaco-Benzing, R., Ha-Brookshire, J. (2016). Sustainability as social contract: textile and apparel professionals' value conflicts within the corporate moral responsibility spectrum. *Sustainability*, 8(12), 1278.
5. Mandziuk, I.A., Ivanishena, T.V., Prysiazhna, K.O., Mandziuk, O.P. (2016). Calculation of human potential for toxicity by transformation of the experimental research data on biotest object. *Herald of Khmelnytskyi National University*, 2(235), 224–230. doi: 10.31891/2307-5732
6. Muthu, S. (2015). *Handbook of Life Cycle Assessment (LCA) of Textiles and Clothing*. USA: Woodhead Publishing.
7. Shen, B., Li, Q., Dong, C., Perry, P. (2017). Sustainability issues in textile and apparel supply chains. *Sustainability*, Special Issue, 9(9), 1592.

Undergraduate Business Students' Perceptions of Accounting Practices and Profession

Aleksandra Pečiūrienė

University of Applied Sciences, Lithuania
E-mail: a.peciuriene@vfv.viko.lt

Keywords: perceptions of accounting, accounting profession, creativity, students.

JEL codes: M41, M49.

Introduction

Attraction of prime students interested in studying at HEIs for an accounting major degree internationally remains a constant challenge to the accounting profession since the 1990s. Developing globalisation of economy, growing complexity of businesses, information and financial technology revolution, creation of innovative accounting instruments have had a significant impact on accounting practices from then until nowadays. To meet the demands it faces the profession needs to be attractive for students who have the potential to become both technically competent professionals with good analytical abilities and communicative team players, able to understand the expanding business environment and think creatively. Unfortunately, potential students may possess false perceptions of accounting practices and profession (hereinafter referred to as “perceptions of accounting”). Prior studies on the topic have shown that societal perceptions and stereotypes are important issues influencing students' decisions about pursuing an accounting career (Saemann, Crooker, 1999; Byrne, Wills, 2005; Jeacle, 2008; Carnegie, Napier, 2010; Bryant, Stone, Wier, 2011; Baxter, Kavanagh, 2012; McDowal, Jacklin, Natoli, 2012; Quezada, Chi, 2013; Bekoe et al., 2018; Hatane et al., 2019). Although students' perceptions continue to play an important role in their career decision-making, internationally in the last decade there has not been enough studies on the topic in the field of accounting.

The aim of the research is to explore perceptions of accounting of the students enrolled in the studies for non-accounting major degree of Professional Bachelor in Business Administration at Lithuanian HEIs. Accordingly, the main tasks of the research are:

- To study assessing approaches and tools used in the notable prior research on the topic.
- To assess the perceptions of accounting of the target group of the undergraduate business students and determine significant influences on these perceptions.

The main research methods used in the study are the analysis of relevant international resources, questionnaire survey, statistical analysis, comparison and generalization.

1. Notable prior research

Saemann, Crooker (1999) were the first scholars who developed and applied an instrument to capture perceptions of distinct aspects of the accounting profession, which the authors

had abbreviated as PAPI. The PAPI originally included 36 pairs of adjectives representing opposing “creative or creativity friendly” versus “traditional or stereotypical” views on the accounting practices and profession. Approximately one half of the suggested pairs were reverse-coded. The respondents had to tick an appropriate number on the 5-point scale to express the strength of opinion in a particular direction within each pair of adjectives. Further executed principal components analysis allowed the authors to suggest four distinctive factors captured students’ perceptions of accounting, namely: structure, precision, solitary and curiosity. Eventually Saemann, Crooker (1999) discovered that interviewed undergraduate business and non-business students equally tended to find accounting less attractive or interesting – pro rata more boring, dull, monotonous and tedious – if they stuck to traditional perceptions about structure and solitude of the accounting practices. A differential factor in attracting creative individuals into the profession was related to accessing of the receptiveness and precision of accounting practices.

The PAPI has been internationally applied in a substantial body of differently purposed subsequent studies (including Worthington, Higgs, 2003, 2004; Byrne, Willis, 2005; Bryant, Stone, Wier, 2011; Baxter, Kavanagh, 2012; McDowal, Jackling, Natoli, 2012). They were aimed at examining students’ perceptions of accounting, finance, and economics as such or in connection with the influences on students’ choice of academic major, career decision, etc.

2. Methodological background

The target group of the research is the students enrolled in the studies for non-accounting major degree of Professional Bachelor in Business Administration at Lithuanian HEIs. It was not possible to find statistics that precise on the numbers of students specifically enrolled in the above-mentioned studies. However, according to the Lithuanian Department of Statistics (Oficialios statistikos portalas, no date), the population of students studied in Lithuanian colleges, non-university type HEIs, in the beginning of 2019-2020 AY amounted to 32.9 thousand people and in the beginning of 2020-2021 AY it decreased by 1.2% to 32.5 thousand people. The *Sample Size Calculator* (Creative Research Systems, no date) was used to calculate the sample size of the respondents for the study based on that available data. The 95% confidence level together with 5% confidence interval is considered sufficient and acceptable for calculation of the sample size for reflecting the population in empirical researches within the scope of social sciences. Thus, it was estimated that the target group’s sample should be amounted to 380 respondents.

A nonprobability convenience sampling method was used for the selection of respondents. The survey was conducted during 2019-2020 AY and 2020-2021 AY. The students of the Business Management Faculty of Vilniaus Kolegija / University of Applied Sciences enrolled in studies for the degree of Professional Bachelor in Business Administration and have had to study basic accounting courses under their curriculums in 2019-2020 AY and 2020-2021 AY respectively, participated in the survey. The respondents had to complete a survey instrument online before the beginning of the relevant accounting course striving to reveal the perceptions of accounting that they had already accumulated. The total number of collected and accepted questionnaires amounted to 537 units. On this basis, recalculated confidence interval of the actual sample size decreased to 4.2%.

The first section of the survey instrument consisted of a range of respondents' demographic and other profiling questions. The second section of the instrument collected the data on the surveyed students' perceptions of accounting. Mainly it was composed of the modified PAPI with inverted "originally" reverse-encoded pairs of views on the accounting practices and profession. Therefore, all pairs of adjectives on the left side represented "creative or creativity friendly" versus "traditional or stereotypical" views on the right side. The respondents had to tick an appropriate number on the 5-point scale to express the strength of their opinion in a particular direction within each stated pair of views. Besides, in the same section the surveyed students had to indicate various influences on their perceptions of accounting.

The research respected the ethical principles of the respondents' free self-determination and informed readiness to participate in the survey. The survey was conducted anonymously, and the collected data was processed and made public in a generalised form.

The data collected during the survey was analysed and visualized using the Microsoft Excel and the IBM SPSS Statistics software.

3. Research findings

Table 1 provides the descriptive statistics on demographic and study data of the surveyed students. The majority of the respondents were female aged under 29 years old and not experienced in accounting studies (339 or 63.1% of total respondents). It is also worth noting that only 20 or 3.7% of the total respondents had experienced some prior study of accounting.

Table 1. Descriptive statistics on demographic and study data of surveyed students

Age	≤ 29			≥ 30			Overall		
	Male	Female	Total	Male	Female	Total	Male	Female	Total
Not studied accounting	152	339	491	6	20	26	158	359	517
Studied accounting	9	9	18	0	2	2	9	11	20
Total	161	348	509	6	22	28	167	370	537

Source: compiled by the author based on the survey data

Analysis of influences on the students' perceptions of accounting disclosed *internet* (412 or 76.7% of total respondents) the most important influence. Other significant influences were *familiar non-family accountants* (220 or 41.0%), *books* (195 or 36.3%), *movies* (190 or 35.4%), *broadcasting* (156 or 29.1%), *personal work experience* (146 or 27.2%), *accountants family-members* (140 or 26.1%), *teachers* (131 or 24.4%) and *earlier studied subjects* (117 or 21.8%).

To ensure the consistency with the investigation of Byrne, Willis (2005), McDowal, Jackling, Natoli (2012) on the factors of perceptions of accounting, this research explored the same four factors. The internal reliabilities (Cronbach's Alphas) of each factor ranged from

0.754 to 0.863; Definite – 0.829; Boring – 0.755; Precise – 0.863; Compliance driven – 0.827. Table 2 submits appropriate overall mean scores of each factor calculated on gender basis of the respondents and in total. It is notable that calculated factors' mean scores of males were lower than of females in both age groups as well.

Table 2. Mean scores of the perceptions' factors

Gender	Definite	Boring	Precise	Compliance driven
Male	3.58	3.20	3.80	3.35
Female	3.85	3.35	4.10	3.57
Total	3.76	3.30*	4.00	3.50
Sig. (2-tailed) p	0.000	0.000	0.000	0.000

Source: compiled by the author based on the survey data

Further separate multiple linear regressions were deliberated on each of the four factors using such independent variables as explored demographic data and significant influences on perceptions of accounting of the surveyed students.

Conclusions and insights

The most important reported influence on the surveyed students' perception of accounting was the internet. This is slightly different from the relevant findings of other researchers. To ensure the consistency with the previous investigation, this research explored the same four factors of perceptions of accounting – Definite, Boring, Precise, and Compliance driven. The calculated internal reliabilities and total overall mean scores of these factors fairly compare with those reported in both studies mentioned in the text. Therefore, results of the factors' investigation suggest that the surveyed students despite their gender in the mass held traditional stereotypical perceptions of accounting. Moreover, the composed multiple linear regressions for each of the four factors of perception of accounting did not allow to ascertain any independent variable that would be statistically significant for all four factors. Due to sufficient number of the respondents participated in the accomplished survey given conclusions in overall are applicable to the target group of the research.

In order to reduce the risk of bias, the research issues would benefit from further replication. Finally, it is purposive to expand the target group of the research by including undergraduate students enrolled in university level studies and (or) in studies for accounting major degrees at Lithuanian HEIs.

References

1. Baxter, P., Kavanagh, M. (2012). Stereotypes, students' perceptions and inherent creativity: Further Australian evidence. *Australasian Accounting Business and Finance Journal*, 6(5), 81–100. Available at: <https://ro.uow.edu.au/cgi/viewcontent.cgi?article=1399&context=aabfj> [accessed 4 September 2021].
2. Bekoe, R.A. et al. (2018). Attitudes towards accounting and intention to major in accounting: a logistic regression analysis. *Journal of Accounting in Emerging Economies*, 8(4), 459–475. doi: <https://doi.org/10.1108/JAEE-01-2018-0006>

3. Bryant, M., Stone, D., Wier, B. (2011). An exploration of accountants, accounting work, and creativity. *Behavioral Research in Accounting*, 23(1), 45–64. doi: <https://doi.org/10.2308/bria.2011.23.1.45>
4. Byrne, M., Willis, P. (2005). Irish secondary students' perceptions of the work of an accountant and the accounting profession. *Accounting Education: An International Journal*, 14(4), 367–381. doi: <https://doi.org/10.1080/06939280500346003>
5. Carnegie, G., Napier, C. (2010). Traditional accountants and business professionals: Portraying the accounting profession after Enron. *Accounting, Organizations and Society*, 35(3), 360–376. doi: <https://doi.org/10.1016/j.aos.2009.09.002>
6. *Creative Research Systems* (no date). *Sample Size Calculator*. Available at: <https://www.surveysystem.com/sscalc.htm> [accessed 4 September 2021].
7. Hatane, S.E. et al. (2019). The dimensions of accounting profession in the view of high school students as the generation z. *Journal of Education and Learning*, 13(4), 550–550. doi: <https://doi.org/10.11591/edulearn.v13i4.13370>
8. Jeacle, I. (2008). Beyond the boring grey: The construction of the colourful accountant. *Critical Perspectives on Accounting*, 19(8), 1296–1320. doi: <https://doi.org/10.1016/j.cpa.2007.02.008>
9. McDowall, T., Jackling, B., Natoli, R. (2012). Are we there yet? Changing perceptions of accounting as career preference. *The International Journal of Learning*, 18(4), 335–352. doi: <https://doi.org/10.18848/1447-9494/CGP/v18i04/47574>
10. Oficialios statistikos portalas (no date). *Kolegijų studentai 2016–2017 – 2020–2021 m. m.* Available at: <https://osp.stat.gov.lt/statistiniu-rodikliu-analize?indicator=S3R258#/> [accessed 4 September 2021].
11. Quezada, A., Chi, Y.N. (2013). Knowing how business students choose accounting as a major. *Journal of Business and Economics*, 4(2), 124–134. Available at: <http://www.academicstar.us/issueshow.asp?daid=756> [accessed 4 September 2021].
12. Saemann, G.P., Crooker, K.J. (1999). Student perceptions of the profession and its effect on decisions to major in accounting. *Journal of Accounting Education*, 17(1), 1–22. doi: [https://doi.org/10.1016/S0748-5751\(99\)00007-X](https://doi.org/10.1016/S0748-5751(99)00007-X)
13. Worthington, A., Higgs, H. (2003). Factors explaining the choice of a finance major: the role of students' characteristics, personality and perceptions of the profession. *Accounting Education: An International Journal*, 12(3), 261–281. doi: <https://doi.org/10.1080/0963928032000088831>
14. Worthington, A., Higgs, H. (2004). Factors explaining the choice of an economics major: the role of student characteristics, personality and perceptions of the profession. *International Journal of Social Economics*, 31(5/6), 593–613. doi: <https://doi.org/10.1108/03068290410529416>

A Digital Platform as a Diverged Type of Digital Business Models

Svitlana Pokhylko

Sumy State University, Ukraine,
E-mail: s.pokhylko@finance.sumdu.edu.ua
ORCID iD: 0000-0001-5739-2795

Tetiana Dvorianova

Sumy State University, Ukraine
E-mail: tetianka.dvorianova@gmail.com

Keywords: digital platform, digital business model, digitalization, business model canvas, online business.

JEL code: L 81, M 21, O11.

Introduction

Digitalization is a universal trend today, transforming methods and means of management, approaches to managerial decision-making, and the economy as a whole. Knowledge becomes the main factor - not only knowledge as an intellectual resource, but knowledge as an information base, information about the system of connections. Companies use them to form new business models that are effective in today's environment. One such business model is the digital platform.

The growth of digital platform usage is huge and there is no tendency that it is going to slow down soon. For a clearer analysis of the terms used and in order to define the linkage of the study fields, we applied the methods of new bibliometric analysis from the WEB of Science - Scopus. «Digital platform» was the chosen key word. The growing number of documents (Figure 1), indicates that the field of study is growing over time, almost reaching its peak but it is the time that will show us whether the year 2020 with its 4145 documents is the highest point or not. The first article mentioning this term was recorded in 1961 – it is more than 40 years ago from the time Scopus database emerged! The total number of works in the Scopus database

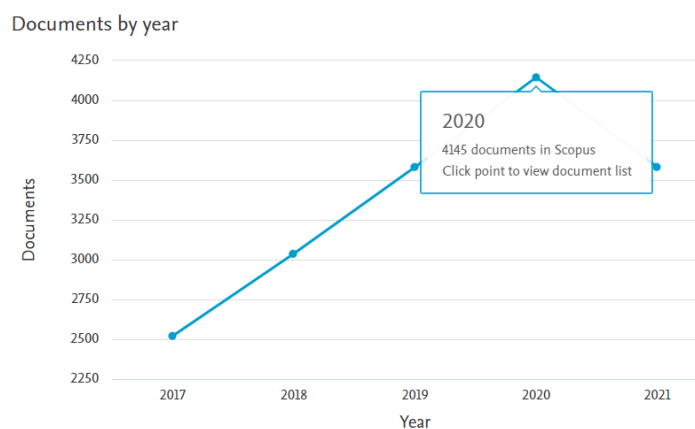

Figure 1. The trend of academic publications mentioning the term “digital platform” for the past 5 years

Source: compiled by authors based on the Scopus database

mentioning the term “digital platform” is 63,002 (as of the beginning of the 4th quarter of 2021).

The research is extended up to 3 pages. Quantitative Techniques or Tools were used in dealing with this particular publication - documents screening, in particular.

1. Digital platforms

Platformization is referred to many sources as a threat to traditional business. This is because deploying a digital platform is much cheaper than deploying a production or service delivery service. It does not require significant logistics, a large number of employees, and the like. One of the clearest examples is the replacement of the traditional cab service with new applications. In fact, familiar to us services like Uber, Bolt and a new one Uklon are services which do not have their own fleet of cars (cars belong to their owners, are registered in the application), do not have dispatchers (who provide contact of the customer and driver), but they can meet the needs of consumers and provide work for drivers (Dean, 2021).

There are four main types of digital business models. Those are widely known kinds as B2C – Business to consumer, B2B – Business to business, C2B – Consumer to business, C2C – Consumer to consumer. From a slightly different perspective, the digital platform, to be more specified, has a variety of businesses. For instance, social media platforms, knowledge platforms (notion.so, prometheus.org.ua), media sharing platforms, service-oriented platforms. The business model canvas, consists of nine building blocks: customer segments, channels, customer relationships, revenue streams, key resources, key activities, key partnerships, cost structure, and value propositions. Any digital model that is made for making money has to have the same blocks in planning future steps.

What is the difference between digital business models and digital platforms in simple words? The first one is a solution for a customer’s affairs, whereas digital platform is just a cloud technology where the created solution can be implemented on. For example, Spotify, Snapchat and Domino’s are embodied in an utterly famous Google platform. Business Models can also be brick-and-mortar stores though, not just an online business. A restaurant or a café can be a perfect example as we can’t eat through our digital devices.

2. Value of digital platforms

In fact, this is why the term “uberization” arose, which characterizes the new business model that eliminates intermediaries (dispatchers) and provides cost savings. Another advantage of platforms is that they are easy to scale. If market expansion for traditional business implies significant costs for formation of a distribution network, promotion of products to the market, the cost and value of the platform grows along with the growth of the number of consumers according to the law of Metkaf: the utility of the network is approximately equal to half the square of the number of users (Alabi, 2017). Accordingly, a platform that is not filled with users has no value. This new business model is aimed at forming a contact between the consumer and the producer, rather than direct sales. It is found in many areas - sales, finance, education, services, and so on.

Platforms are quickly gaining traction because they are beneficial to all involved:

- the service provider (the seller on the platform) gets a wide range of potential customers, the number of which grows along with the number of providers themselves. There is no need to bear the cost of paying for a domain, developing your own site, and spending time and effort to promote it;
- the consumer gets personalized offers, because the platform can analyze information about him or her, his or her experience on the platform, behavior, and based on these data offer similar products and services;
- the platform forms its own conjuncture, because the more participants-suppliers, the more competition and the higher the price level can be leveled;
- the cost of using the services of the platform for the consumer is either none or very low. In the same way, the vendor spends a minimum of finances to promote its products. For example, ads on Facebook and Google are inexpensive. But at the same time, the platforms themselves, due to the large number of users and transactions, can generate significant revenues.

Meanwhile, as of the end of 2020, Facebook was used daily by 4480000000 people, who on average generated \$7.37. This total allows the company to collect more than \$17 billion in revenue each day. The company has a total of almost 86 billion USD (Statista Research Department, 2021).

Conclusions

The term business model has been used in practice for several years, and companies have directly or indirectly created, defined and innovated their business models with the aim of gaining a better position in the market. It can be said that the business model canvas has been widely adopted and transformed by business people. There are a considerable amount of digital platforms as a new form of business models available for e-commerce and dropshipping business now, which are widely popular nowadays, taking into account the current lockdown and pandemic situation all over the world (Charm, et al., 2020).

References

1. Alabi, K. (2017). Digital blockchain networks appear to be following Metcalfe's Law. *Electronic Commerce Research and Applications*, 24, 23–29. <https://doi.org/10.1016/j.elerap.2017.06.003>
2. Charm T., Coggins B., Robinson K., Wilkie J. (2020). *The great consumer shift: Ten charts that show how US shopping*. McKinsey & Company. Available at: The great consumer shift: Ten charts that show how US shopping behavior is changing | McKinsey [accessed 15 October 2021].
3. Dean B. (2021). *Social Network Usage & Growth Statistics: How Many People Use Social Media in 2021?*, Backlinko. Available at: <https://backlinko.com/social-media-users> [accessed 15 October 2021].
4. Statista Research Department (2021). *Facebook: annual revenue 2009-2020*. Statista, <https://www.statista.com/statistics/268604/annual-revenue-of-facebook/> [accessed 15 October 2021].

Models and Factors of Auditor's Professional Skepticism

Daiva Raziūniene

Vilnius university, Lithuania

E-mail: daiva.raziuniene@evaf.vu.lt

Keywords: professional skepticism, model, factors, auditor.

JEL Classifications: M42.

Introduction

This paper examines academic research literature related with the auditors' skeptical judgement and decisions. The main *purpose* of the research is according to academic research papers and conceptual description of the professional skepticism to identify modeling of auditor's professional skepticism. Tasks for that are to analyse different models and provide main factors that influence processes or measurement of this subject.

Literature review *method* is used to provide scientific issues discussed in the international leading scientific journals during last decade. Inductive and deductive methods of analysis provide opportunity to analyse recent academic framework of understandings related with the professional skepticism level and their implementation issues.

1. Models of Auditor's professional skepticism

Professional skepticism of auditors is considered an especially important factor of auditing and audit quality. Auditing standards describe requirements to evaluate audit evidence with an attitude of skepticism. Professional skepticism is that element that is missed when audit failures occur.

Professional skepticism according to Kee, Knox's model is a function of ethical disposition, experience, and situational factors (Shaub, Lawrence, 1996). Professional skepticism is auditors' assessment of client truthfulness (Payne, Ramsay, 2005).

There are two prevailing perspectives that have surfaced neutrality and presumptive doubt. Neutrality can be defined as auditors neither believing nor disbelieving management assertions. Presumptive doubt means auditor's assumptions about some level of dishonesty made by client management, unless evidence indicates otherwise (Quadackers, Groot, Wright, 2014).

Consistent with much research and with recent regulatory concerns, professional skepticism is indicated by auditor judgements and decisions that reflect a heightened assessment of the risk that an assertion is incorrect, conditional on the information available to the auditor (Nelson, 2009).

Professional skepticism is a multi-dimensional individual characteristic. As an individual characteristic, professional skepticism can be a trait and a state. Trait means a relatively stable, enduring aspect of an individual and also a state means a temporary condition aroused by situational variables (Hurtt, 2010).

Actually, researchers identify different factors that are important for skepticism definition and measurement (see Table 1).

Table 1. Contemporary models of Auditor’s professional skepticism

Authors	Model’s Title	Factors of the models
Hurt R.K. (2010)	Scale of Measurement	Trait and Behavior
Glover, Prawitt (2014)	Skepticism continuum	Complete Trust v. s. Complete Doubt (Forensic mind-set)
Hurt, Brown-Liburd, Earley, Krishnamoorthy (2013)	A model of antecedents & outcomes	Observed Judgment and Action outcomes
(Nelson, 2009)	Model of determinants	Evidential input, skeptical judgement, skeptical action, evidential outcome
(Nolder, Kadous, 2018)	Antecedents &Consequences of PS	Antecedents &Consequences
(Cohen, Dalton, Harp, 2017)	Hypothesized Model of Auditor’s PS	Turnover intentions, perceived partner support, perceived organizational support.
(Brazel et al., 2016)	Three-path mediation model	Total & direct effect between outcome and evaluation
(Yuen et al., 2013)	Multinomial logistic regression models	Independent variables(6 Hurt scale elements) and additional variables (experience, certificates and fraud audit experience)

Source: compiled by author based on sources listed in the table

Hurt R.K. (2010) develops a scale designed to *ex ante* measure an individual’s level of trait professional skepticism based on characteristics derived from audit standards, psychology, philosophy, and consumer behaviour research. Accepting the multi-dimensionality of professional skepticism, the researcher identifies six characteristics that comprise professional skepticism: a questioning mind, a suspension of judgement, a search for knowledge, interpersonal understanding, self-esteem, and autonomy. Nelson (2009) provides a model that describes how audit evidence combines with auditor knowledge, traits, and incentives to produce actions that reflect relatively more or less professional skepticism.

Glover, Prawitt (2014) propose a “professional skepticism continuum” that acknowledges that the appropriate application of professional skepticism will depend on the risk characteristics of the account and assertion.

Both researchers and regulators have emphasized the importance of an appropriate level of auditor’s professional skepticism. However, this concept remains a hard subject that can be properly defined and measured.

Conclusions (recommendations, debatable issues)

1. Future scientific research should analyse specific elements of proposed models. A questionable area regarding trait and behaviour is the level to which different elements of professional skepticism can be affected. Another task is to test a potential barrier to skepticism.

2. Six measurement factors are used to describe the level of individual's professional skepticism, which is associated with personal characteristics. Additional variables can be used to manipulation the auditor's professional skepticism level. For example, experience in forensic audits, fraud investigation, time or resources limits.
3. Debatable issues should be related to an investigation of direct and indirect incentives to avoid inefficiencies.

References

1. Brazel, J. F. et al. (2016). The outcome effect and professional skepticism. *Accounting Review*. doi: 10.2308/accr-51448
2. Cohen, J. R., Dalton, D. W., Harp, N. L. (2017). Neutral and presumptive doubt perspectives of professional skepticism and auditor job outcomes. *Accounting, Organizations and Society*, 62. doi: 10.1016/j.aos.2017.08.003
3. Glover, S. M., Prawitt, D. F. (2014). Enhancing auditor professional skepticism: The professional skepticism continuum. *Current Issues in Auditing*, 8(2), P1–P10. doi: 10.2308/ciia-50895
4. Hurtt, R. K. (2010). Development of a scale to measure professional skepticism. *Auditing*, 29(1), 149–171. doi: 10.2308/aud.2010.29.1.149
5. Hurtt, R. K. et al. (2013). Research on auditor professional skepticism: literature synthesis and opportunities for future research, *AUDITING: A Journal of Practice & Theory*, 32(Supplement 1), 45–97. doi: 10.2308/ajpt-50361
6. Nelson, M. W. (2009). A model and literature review of professional skepticism in auditing. *Auditing*, 28(2), 1–34. doi: 10.2308/aud.2009.28.2.1
7. Nolder, C. J., Kadous, K. (2018). Grounding the professional skepticism construct in mindset and attitude theory: A way forward. *Accounting, Organizations and Society*. 67(March), 1–14. doi: 10.1016/j.aos.2018.03.010
8. Payne, E. A., Ramsay, R. J. (2005). Fraud risk assessments and auditors' professional skepticism. *Managerial Auditing Journal*. doi: 10.1108/02686900510585636
9. Quadackers, L., Groot, T., Wright, A. (2014). Auditors' professional skepticism: neutrality versus presumptive doubt. *Contemporary Accounting Research*, 31(3), 639–657. doi: 10.1111/1911-3846.12052
10. Shaub, M. K., Lawrence, J. E. (1996). Ethics, experience and professional skepticism: A situational analysis. *Behavioral Research in Accounting*, 124. Available at: <http://search.ebscohost.com/login.aspx?direct=true&db=buh&AN=7709670&site=ehost-live>.
11. Yuen, D. C. Y. et al. (2013). Dysfunctional auditing behaviour: empirical evidence on auditors' behaviour in Macau. *International Journal of Accounting and Information Management*, 21(3). doi: 10.1108/IJAIM-12-2012-0075

The Impact of IFRS Adoption on Lithuanian Companies' Financial Ratios

Kristina Rudžionienė

Vilnius University, Lithuania

E-mail: Kristina.rudzioniene@knf.vu.lt

ORCID iD: <https://orcid.org/0000-0001-8111-5675>

Miglė Černiauskaitė

Vilnius University, Lithuania

E-mail: miglecerniauskaite1@gmail.com

Rūta Klimaitienė

Vilnius University, Lithuania

E-mail: Ruta.klimaitiene@knf.vu.lt

ORCID iD: <https://orcid.org/0000-0002-0754-1593>

Keywords: IFRS adoption, financial ratios, impact, Lithuania.

JEL code: M41, G30.

Introduction

Each country in the world regulates its accounting system independently. The main idea of creating and issuing International Accounting Standards, later International Financial Reporting Standards (IFRS), was to harmonize accounting in the world, and to improve the comparability and transparency of financial statements so that users of financial statements can more easily compare companies in their investment process when making financial and economic decisions, although other economic consequences are also expected after this process. Now IFRS are mandatory, implemented in 87 percent of jurisdictions (Ball, 2016; IASB, 2018), mostly for listed companies. But other companies may choose an accounting regulation system between domestic accounting standards and IFRS. Therefore, companies may voluntarily use IFRS according to their accounting practice, characteristics, and needs of the users of accounting information.

With the transition to other accounting regulations, the numbers of the financial statements may be accounted for and measured differently, as a result of which the financial ratios derived from them and used for the financial analysis may also undergo certain changes. Therefore, the impact of IFRS adoption on accounting quality, comparability of financial statements, transparency, cost of capital, foreign investments and many other aspects has been examined in the context of the widespread implementation of IFRS worldwide. The impact on the financial performance of companies is not as widely examined in the literature as the impact on the quality of accounting or the comparability of financial statements, because IFRS adoption was not focused on changes in financial performance. But the impact on financial ratios is also an important economic change for a company, as they are the

main indicators of the company's financial position, and are used by the company's managers and employees, investors, creditors and regulatory institutions.

In much research, the impact of IFRS adoption on a company's financial ratios is not clear. Some research results do not show any significant change in financial ratios after IFRS adoption. Many studies show that IFRS adoption has undergone significant changes. Hence, we need further evidence from an Eastern European country to assess the latest implications of IFRS adoption on financial ratios in a globally harmonized accounting world.

The main objective of this study was to evaluate the impact of IFRS adoption on the financial ratios of Lithuanian state-owned companies (SOEs).

The methods of this study. The researchers used systematic and comparative analysis of scientific literature, synthesis, generalization, and induction method for the analysis of empirical research. Secondary data were manually collected from the SOEs' financial statements in websites, and statistical analysis was performed for the empirical study. To evaluate the impact of IFRS adoption on financial ratios, researchers applied descriptive statistics measures (averages, medians), Gray's Comparability Index, Shapiro Wilk test, F-test, t-test and non-parametric Wilcoxon Signed Rank test of selected financial ratios computed under IFRS and BAS by using Statistical Package for Social Science (SPSS) software.

Organization of the research

After the analysis of previous literature, there were formulated three hypotheses:

H1: IFRS adoption significantly increases profitability ratios of Lithuanian companies.

H2: IFRS adoption significantly decreases liquidity ratios of Lithuanian companies.

H3: IFRS adoption significantly increase leverage ratios of Lithuanian companies.

The profitability, liquidity and leverage ratios were selected for the research: ROA, ROE, ROS, net profit margin, current ratio, quick ratio, leverage ratio, debt ratio and equity ratio.

Two-year financial ratios (before and after IFRS adoption) were calculated and descriptive statistics, which include averages, medians and their changes, were analyzed. Data were measured using the Gray Comparability Index to estimate the relative change of financial ratios after IFRS adoption. Further the Shapiro-Wilk test was used to verify normality in subsequent statistical analysis, and the t-test and Wilcoxon test were used to analyze the hypotheses, comparing the selected financial ratios (average and median respectively) before and after IFRS adoption.

The sample of the research included 15 Lithuanian SOEs that adopted IFRS in the 2011–2018 period. Most of these enterprises operate in the transport, financial, service and television services sectors, and there are several manufacturing companies.

Conclusions

The research results showed that IFRS adoption is related to decreased averages and medians of profitability ratios, but some changes of ratios were stronger, some were very weak. But the change in profitability ratios after IFRS adoption was not significant. Liquidity ratios also decreased after IFRS adoption, but the change also was not statistically significant. Averages and medians of leverage ratios increased after IFRS adoption, except for the financial leverage ratio, which had a negative strong change of average. The results of the statistical analysis showed that the financial leverage ratio and the debt ratio had a statisti-

cally significant change: the debt ratio increased significantly, and the financial leverage ratio decreased significantly based on the change in the average and the Gray Comparability Index. The equity ratio had a very small insignificant increase.

Comparing the obtained results with the results of other studies, it can be seen that similar results are obtained only with leverage ratios. Profitability ratios in most previous studies increased, but there were some cases of decrease: the same result was obtained in this study. The decrease in liquidity ratios coincides with a third of the research of other authors discussed, but other authors also discussed the increase in ratios or the absence of change. Our results show a statistically significant increase in debt ratio, but the other two ratios do not concur with the results of similar research.

References

1. Ball, R. (2016). IFRS–10 Years Later. *Accounting and Business Research*, 46(5), 545–571. <https://doi.org/10.1080/00014788.2016.1182710>
2. Istrate, C. (2013). Impact of IFRS on accounting data–Gray Index of conservatism applied to some European Listed Companies. *Analele Științifice ale Universității «Alexandru Ioan Cuza» Iași. Științe economice*, 60(2), 259–277. Available at: http://saaic.feaa.uaic.ro/index.php/saaic/article/view-File/100/pdf_45
3. Jindřichovská, I., Kubičková, D. (2014). Impact of International Financial Reporting Standards (IFRS) adoption on key financial ratios: the case of the Czech Republic. *Journal of Modern Accounting and Auditing*, 10(2), 133–146.
4. Lantto, A. M., Sahlström, P. (2009). Impact of International Financial Reporting Standard Adoption on key financial ratios. *Accounting and Finance*, 49(2), 341–361. <https://doi.org/10.1111/j.1467-629X.2008.00283.x>
5. Sovbetov, Y. (2015). How IFRS affects value relevance and key financial indicators? Evidence from the UK. *International Review of Accounting, Banking and Finance*, 7(1), 73–96. <https://dx.doi.org/10.2139/ssrn.2394507>
6. Utku, M., Kaya, Y. (2019). IFRS adoption in Europe: the case of industrial sectors. In *Studies on Interdisciplinary Economics and Business* (edited by Özçelik, Ö.). Volume II. Peter Lang GmbH. 287–301.

Review of Performance Audit Impact Studies

Asta Šalienė

Vilnius University, Lithuania

E-mail: asta.saliene@cr.vu.lt

ORCID iD: <https://orcid.org/0000-0002-1353-3709>

Daiva Tamulevičienė

Vilnius University, Lithuania

E-mail: daiva.tamuleviciene@evaf.vu.lt

ORCID iD: <https://orcid.org/0000-0002-0187-037X>

Keywords: Supreme Audit Institution, performance audit, audit impact.

JEL code: H83, M42.

Introduction

The studies in the field of the impact of the performance audit are an important part of understanding the usefulness of this kind of audit. The literature analysis revealed that there are a few different types of the performance audit impact. Despite studies on various forms of impact, there is a gap in research. This gap is the impact on the user – the public – of the performance audit results. The purpose of the study is to explain the variety of impacts of performance audits and justify the necessity to continue researching the field. The task of review is to investigate the studies carried out, explain the variety of impacts, find gaps in those studies and define the field for further research. The object of the study is the impact of performance audit. The following research methods were used: review of scientific literature, content analysis.

1. Impact of performance audit and its classification

In the Performance audit standard ISSAI 3000, (INTOSAI, 2019b) declared that the auditor shall conduct the process of selecting the audit topics with the aim of maximising the expected impact of the audit while taking account of audit capacities. The impact of a performance audit can also be explained as an “outcome”.

From the academic perspective, the performance audit impact has a much broader meaning. Performance audit impact studies were started approximately three decades ago. It is not a long time for a science. The first studies of the impact of performance audits in scientific sources were conducted in Australia (Hatherly, Parker, 1988), the United States (Johnston, Jr., 1988), the Netherlands (Van der Meer, 1999).

Research in the performance audit field was impacted by political, economic, technological, and social causes. Taxpayers are becoming increasingly educated and legitimately expect the managers of government finance to be accountable for the use of tax funds and citizens and the society reap the maximum benefit from public finances. Therefore, the pub-

lic sector is encouraged to improve the governance of organizations, increase the responsibility and accountability of managers and various levels of the government.

However, the research on the impact of performance audits has revealed that the science is still looking for the most appropriate research methods to assess whether conducted SAI performance audits bring benefit to the society, help to create public value, contribute to the well-being and public interest.

In the scientific literature, the impacts of the performance audit are classified into several forms. Many researchers use a framework of the performance audit impact consisting of five forms: instrumental; conceptual; interactive; impact through political legitimacy; tactical (Table 1).

Table 1. Forms of the performance audit impact

Form	Location of impact	Continuity	Ability to measure
Instrumental	Object of recommendations	Short period	Easy
Conceptual	Slow but successful change in perception, comprehension, mental level	Long period	The evaluation is difficult and complicated
Interactive	Negotiation, consensus between stakeholders	Medium period	Difficult
Impact through political legitimacy	Media reaction, interest of politicians	Short period, instantaneous	Easy
Tactical	Decision making	Short period, instantaneous	Easy – medium

Source: compiled by the authors

Should be noted that there is another form of performance audit impact in the scientific literature—the impact on the intended users as defined in ISSAI 3000 (INTOSAI, 2019b) and GUID 3910 (INTOSAI, 2019a). There are just a few studies on the impact on the user—the society and citizens. These studies focus on the impact on the consumers’ satisfaction, well-being as well as the social welfare.

2. The results of the carried out performance audit impact studies

Researchers emphasise different specific areas of performance audit impact and provide their own insights. Morin (2001) concluded that taxpayers should have reasonable grounds to suspect that a performance audit does not always achieve its objective. There is only the illusion that the situation is getting better, which in turn does not guarantee the efficient use of funds. Morin (2008) highlighted the tendency for environmental conditions to affect the work of auditors, leading to the need for environmental impact assessments. Auditors cannot expect to control all the circumstances but should be aware of them. Weets (2008) disagrees with the “popular” indicators most commonly used by SAIs to measure the impact of their performance audits, which usually have only a limited measure of the effectiveness of the performance audit but do not understand the causal links. The study by Torres, Yetano, Pina (2016) revealed that the SAIs in the European Union conducting the state per-

formance audits do not have the sufficient legal power; and the fact that the legal power is not provided by law indicates a lack of political will. Reichborn-Kjennerud, Johnsen (2018) examined the issue of accountability and organizational learning when implementing performance audit recommendations. It also defined the direction for further research, which focuses on how performance audits affect politicians and public policy.

The theoretical background revealed that the results of research to date raise more questions than they answer. It is debatable whether the impact of a performance audit is significant, whether it exists at all, whether a performance audit helps to improve performance, or whether the public benefits fairly from paying taxes. It should be concluded that it does not matter what form of impact is implemented, the priority is public well-being and the creation of public value.

Conclusions

1. The impact of the performance audit covers both the outcome of the auditing process and the long process after the follow-up. It depends on the form of impact. Every form has some special features, such as location, continuity, and the ability to measure it.
2. After analysing the previous studies in the performance audit impact field, it was determined that there is a gap in conducted research. It is the impact of a performance audit on the society, citizens, or the public. According to INTOSAI, the impact of performance audits on the society should be a priority. This gap opens up a wide space for future research.

References

1. Hatherly, D. J., Parker, L. D. (1988). Performance auditing outcomes: a comparative study. *Financial Accountability and Management*, 4(1), 21–41. <https://doi.org/10.1111/j.1468-0408.1988.tb00288.x>
2. INTOSAI [International Organization of Supreme Auditing Institutions]. (2019a). *GUID 3910 Central Concepts for Performance Auditing*. <https://doi.org/www.issai.org>
3. INTOSAI [International Organization of Supreme Auditing Institutions]. (2019b). *ISSAI 3000 Performance Audit Standard*. <https://doi.org/www.issai.org>
4. Johnston, Jr., W. P. (1988). Increasing evaluation use: some observations based on the results at the U.S. GAO. *New Directions for Program Evaluation*, 1988(39), 75–84. <https://doi.org/10.1002/ev.1491>
5. Morin, D. (2001). Influence of value for money audit on Public Administrations: Looking beyond appearances. *Financial Accountability & Management*, 17(2), 99–117. <https://doi.org/10.1111/1468-0408.00123>
6. Morin, D. (2008). Auditors general's universe revisited: An exploratory study of the influence they exert on public administration through their value for money audits. *Managerial Auditing Journal*, 23(7), 697–720. <https://doi.org/10.1108/02686900810890652>
7. Reichborn-Kjennerud, K., Johnsen, Å. (2018). Performance audits and Supreme Audit Institutions' impact on public administration: the case of the Office of the Auditor General in Norway. *Administration & Society*, 50(10), 1422–1446. <https://doi.org/10.1177/0095399715623315>
8. Torres, L., Yetano, A., Pina, V. (2016). Are performance audits useful? A comparison of EU practices. *Administration & Society*, 1(32), 1–32. <https://doi.org/10.1177/0095399716658500>
9. Van der Meer, F. B. (1999). Evaluation and the social construction of impacts. *Evaluation*, 5(4), 387–406. <https://doi.org/10.1177/135638999400830048>
10. Weets, K. (2008). How effective are performance audits ? A multiple case study within the Local Audit Office of Rotterdam. *Paper for the 5th International Conference on Accounting, Auditing & Management in Public Sector Reforms Amsterdam*, 29.

Evaluation of the Competencies of Modern Accounting Specialist: Cases of Lithuania and Latvia

Rasa Subačienė

Vilnius University, Lithuania
E-mail: rasa.subaciene@evaf.vu.lt
ORCID iD: 0000-0001-6559-8478

Ramunė Budrionytė

Vilnius University, Lithuania
E-mail: ramune.budrionyte@evaf.vu.lt
ORCID iD: 0000-0002-6889-5598

Jolanta Žemguliėnė

Vilnius University, Lithuania
E-mail: jolanta.zemguliene@evaf.vu.lt

Iveta Faituša

RISEBA University of Applied Sciences, Latvia
E-mail: ivita.faitusa@riseba.lv
ORCID iD: 0000-0003-4080-9499

Keywords: accounting specialist, competences, Lithuania, Latvia.

JEL code: M41.

Introduction

As much as there are opinions on the decreasing role of accounting specialist and its role at the enterprise as accounting may be robotized and many routine operations may be transferred to technical level, we have to disagree. The number of students on accountancy bodies is increasing and continues to grow. As much as accountant's profession faces many challenges such as rapid change of technologies, business forms, digitalization, new types of currencies, transactions, global pandemic and many others, it's still very important and forms most financial data on the entities. What indicates the need to investigate the background for the profession. The study evaluates the competencies of modern accounting specialist in new economic reality relying on the cases of Lithuania and Latvia.

1. Organization of the research

Under results of literature review and the bases of structured groups of competences by J. Mackevičius and R. Subačienė (2016) authors distinguished 3 groups of competences

of accounting specialist: 1) personal with abilities of accuracy; analytical skills and logical thinking; integrity; ability to resist work routine; ability to learn; responsibility; determination; ability to resist stress and pressure; independence; decision making; creativity; management ability; risk taking, 2) professional with abilities to record economic transaction to accounting documents and registers; to prepare financial statements; to form financial accounting policy; to form tax accounting policy; to form management accounting policy; to form information system of the company; to plan, analyse and evaluate company's performance; to present analysis results, to identify problems and to suggest solutions to problems; to support internal control system; to be interested in innovations and changes in regulation and 3) social with abilities to communicate with colleagues and persons from other institutions; to cooperate with colleagues and persons from other institutions; to work in a team. For the evaluation of competences of modern accounting specialist, the survey was conducted in November, 2020 – April, 2021 in Lithuania and Latvia. Data of 387 responses (182 LT and 205 LV) were assessed by attributes of respondents' country, work experience, current working position and the size category of the entity. Besides the personal, professional and social competences necessary types of professional knowledge were evaluated. Analysis of variance (ANOVA) was used to compare the means of variables in various groups to identify any potentially confounding links. Pearson Chi-Square homogeneity criteria was computed to evaluate the differences. Structure and dimensions of accountant's professional competences were determined by factor analysis. Statistical Package for the Social Sciences was used for the analysis of data.

2. Research results and conclusions

The results of analysis of types of necessary knowledge for tasks and responsibilities the accountant should fulfil during every day work show that around 90 % and more of respondents of both countries identified knowledge of classical accounting and related fields: financial accounting, external reporting, calculation and accounting of taxes, payroll accounting. The smaller the company, the more often financial accounting was indicated as necessary knowledge for the tasks and responsibilities the accountant should fulfil during every day work what maybe be assessed by broader or less specified functions of accountants in micro companies. Most of respondents of different current positions evaluated different types of knowledge as necessary for routine of accounting specialist at quite the same level as well as respondents at different work experience. Except the higher the respondents experience was, the larger part of the group identified the importance of knowledge of related with accounting fields, although the knowledge of languages was evaluated by the respondents with lowest experience at higher level. Such results may indicate the tendency of use of different languages at international companies and young age of employees, who work at such companies. Besides, accounting specialist with higher experience usually take higher positions at companies and require more related accounting information.

The results of the research show, that practical classical personal competencies of the accounting specialist such as accuracy, responsibility, integrity, analytical skills and logical thinking are still relevant and were evaluated at a higher level by respondents of both countries. The size of entities didn't make statistically significant differences on evaluation of the competences, except of the opinion of medium companies on ability to resist stress

and pressure, and the opinion of large companies on independence and creativity, which were evaluated at a lower rate. That indicates conservative viewpoint on personal skills of accounting specialist. Quite similarly respondents of up to 5 years work experience group assessed competencies of analytical skills and logical thinking, integrity, ability to resist work routine, ability to learn, independence, creativity and management ability at lower level than respondents with higher work experience. Again that shows the tendency that typical and classical competences of personal sphere are still main describers of the personality of the profession.

Analysis of the competences of professional sphere indicates, that respondents of both countries similarly assessed the ability to record economic transaction to accounting documents and registers and ability to prepare financial statements as most important competencies of professional sphere. Besides respondents of micro and small companies evaluated abilities to prepare financial statements, to form management accounting policy, to form tax accounting policy, to plan, analyse and evaluate company's performance at a higher level than respondents of medium and large companies, what indicates the diversification of functions in larger companies. Respondents with less work experience were concentrated on traditional competences of professional sphere.

Opinions of respondents of different attributes on competences of social sphere were quite the same, what reflects the results of factor analysis. According to factor analysis all competences were measured by 5 factors and distributed the competences of personal sphere to abilities of accounting specialist to perform classical functions and abilities of higher level specialists. Competences of professional sphere were distributed to capacity of accounting specialist to prepare, systemize and form accounting information and to abilities to analyse and evaluate information, apply new knowledge, competences of social sphere were measured at same way. Factor analysis shows that classification of competences of the profession into three groups (personal, professional and social) is logical and applicable, although it indicates the possibility to prepare the more detail groups and set of competences of accounting specialist.

Generally, may be stated, that regardless the changes the research shows relevance of classical functions and competencies of accounting specialist.

References

1. Mackevičius, J., Subačienė, R. (2016). *Lietuvos buhalterinės apskaitos sistema: praeitis, dabartis, perspektyvos* [Lithuanian Accounting System: Past, Present and Prospects]. Monograph. Vilnius: Academic Publishing.

Analysis of Risk Factors for Applied Projects in the Ecosystem of Digitalization of the Economy

Alexey Petrovich Taburchak

Saint-Petersburg State Technological Institute (Technical University), Russian Federation
E-mail: ta@inbox.ru
ORCID iD: <https://orcid.org/0000-0002-5846-0021>

Svetlana Mikhailovna Bychkova

Saint-Petersburg State Agrarian University, Russian Federation
E-mail: smbychkova@mail.ru
ORCID iD: <https://orcid.org/0000-0001-7684-9025>

Alina Alexandrovna Butina

Saint-Petersburg State Technological Institute (Technical University), Russian Federation
E-mail: alina-butina@yandex.ru
ORCID iD: <https://orcid.org/0000-0002-0001-4125>

Keywords: digital economy, applied projects, risks of implementing applied projects, applied projects requiring capital expenditures, applied projects requiring incurring operating costs.

JEL code: JEL G32, JEL O22, JEL O3.

Introduction

The article substantiates the relevance of the processes of digitalization and informatization of the economy, which entail a systematic transition of the Russian economy to a fundamentally new level - digital (Irtysheva, 2020; Backhaus, 2021). The use of modern digitalization tools ensures the stability of the company's existence in the new conditions (Rincón-Moreno, Ormazábal, Jaca, 2021). These tools are applied projects. The feasibility of using applied projects in the context of modern digitalization of the economy has been proven, since they are the missing link in creating a chain of business transformation on a digital innovation basis in the current realities. (Miroslavskaya, Kozyrev, 2021; Garcez, Silva, Franco, 2021).

The main goal of this study is the development of a methodology for analyzing and assessing risk factors for applied projects, taking into account the specifics of the structure of costs for their development and implementation in the content of the digital economy. The main objectives of the research were: typology of applied projects by types of financial resources; identification of universal risks for various categories of applied projects; development of a methodology for risk analysis by types of applied projects; practical testing of the developed methodology on the existing applied project of PJSC Rostelecom, which requires investment of capital expenditures in excess of the established budget, Smart City.

A special emphasis of the work will be placed on the procedure for the formation of evaluation criteria to determine the probability of the occurrence of risk factors and the

degree of their possible impact on the further implementation of applied projects, as well as the organization as a whole.

The objects of the research were organizations engaged in the creation and execution of applied projects in the context of the development of the digital economy.

The methodology of this research is based on the application of general scientific research methods, such as: analysis and synthesis, comparative analysis, generalization, grouping, classification, deduction, induction.

1. Risk factors for applied projects

All applied projects that can be implemented in a company within the framework of the digital economy can be roughly divided into 3 categories by types of financial investments: applied projects requiring capital expenditures in excess of the budget established by the organization; applied projects requiring capital expenditures within the budget established by the organization; applied projects requiring investment of operating costs (Bychkova, Gogua, Butina, 2019).

Particular attention is paid to the risk factors that must be taken into account for full-fledged uninterrupted work on the creation and execution of applied projects. (Bychkova, Butina, 2018). For each type of applied projects, universal risk factors were identified, which with a high degree of probability can affect the life cycle of applied projects. As an example, Figure 1 shows a set of universal risk factors for applied projects requiring capital expenditures in excess of the established budget.

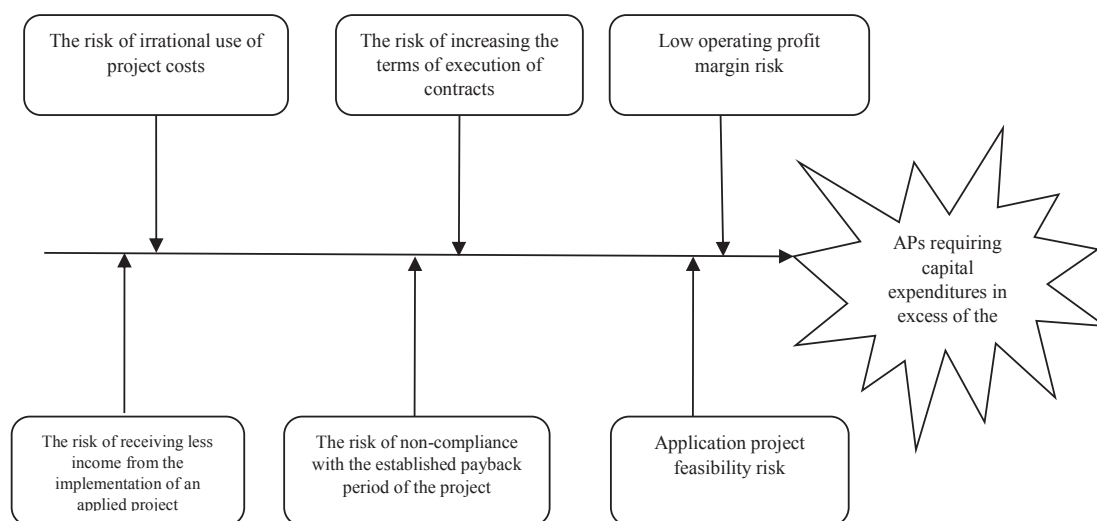

Figure 1. Risks for application projects requiring capital expenditures in excess of budget

Source: developed by the authors

The set of universal risk factors for various types of applied projects is not final and can be changed or supplemented for a specific applied project, since their specificity may cause adaptation of current models of work in accordance with current conditions (Bychkova, Butina, 2019).

2. Risk analysis for applied projects

Within the framework of the developed methodology, risk assessment models were proposed for applied projects requiring capital investments both within and above the budget established by the organization, and operational applied projects. As an example, Table 1 presents a model for assessing risk factors for applied projects requiring capital expenditures in excess of the established budget.

Table 1. Model for the analysis of risk factors for applied projects requiring capital investments in excess of the budget established by the organization

Risk factor	Weight	Grade					Total
		1	2	3	4	5	
Low operating margin	0,25						
Application project feasibility risk	0,15						
The risk of increasing the terms of the contract	0,15						
The risk of non-compliance with the established payback period of the project	0,15	X	X				
The risk of irrational use of project costs	0,10						
The risk of receiving less income from sales	0,20	X	X				
Overall project risk assessment							

Source: developed by the authors

The weighting factors assigned to each factor indicate the importance and significance of this risk for the project and for the financial stability of the enterprise as a whole. After receiving the results of the summary risk assessment of the project, the organization's management can decide on the possibilities of working on this applied project in the current economic conditions.

The study presents practical testing of the proposed models on the example of the Smart City applied project of PJSC Rostelecom, on the basis of which it can be concluded that it is advisable to conduct an assessment of risk factors in relation to a specific applied project (Taburchak, Bychkova, Butina, 2019).

Conclusions (recommendations, debatable issues)

A methodology for analyzing and assessing risks by types of applied projects has been developed. Depending on the type of applied project, the set of risk factors changes, since the larger the scale of a particular project, the larger the horizon for analysis and planning of development and implementation, the higher the probability of risk occurrence. For each type of applied project, a set of universal risk factors is proposed that can be adapted to the needs of a particular firm (Malladi, Soni, Srinivasan, 2021). By analyzing these factors, the organization receives operational information regarding the threats and difficulties in the implementation of applied projects from the market and the digital economy as a whole.

The developed methodology for analyzing the risks arising for an organization during the execution of applied projects makes it possible to analyze, rank and identify the risk factors of the digital economy that most affect the organization's activities (Sorescu, Schreier, 2021). In this case, it is necessary to take into account the importance of each factor for the financial condition of the company (Hanna, 2020). Without carrying out a systematic and regular analysis of the organization's activities in the execution of applied projects, as well as without identifying and promptly identifying risks to the organization's work at all stages of the life cycle of an applied project, it is impossible to implement applied projects as a whole.

References

1. Backhaus, R. (2021). The Second Digital Revolution. *MTZ worldwide*, 82(7), 8–13. DOI: 10.1007/s38313-021-0673-8
2. Bychkova S.M., Butina A.A. (2019). Analysis of the assessment and approval of applied projects requiring investment of capital costs in excess of the established budget. *ETAP*, 2, 139–152. DOI: 10.24411 / 2071-6435-2019-10085
3. Bychkova, S., Gogua L., Butina A. (2019). Risk analysis of the execution of applied projects. In proceedings of the Volgograd State University International Scientific Conference “*Competitive, Sustainable and Safe Development of the Regional Economy*” (CSSDRE 2019), 305–310. DOI: 10.2991/cssdre-19.2019.61
4. Bychkova, S.M., Butina A.A. (2018). Analysis of risks in the implementation of applied projects in the digital economy. *Uchet. Analiz. Audit*, 6, 50–60. DOI: 10.26794 / 2408-9303-2018-5-6-50-60
5. Garcez, A., Silva, R., Franco, M. (2021). Digital transformation shaping structural pillars for academic entrepreneurship: A framework proposal and research agenda. *Education and Information Technologies*, 9, 1–24. DOI: 10.1007/s10639-021-10638-5
6. Hanna, N.K. (2020). Assessing the digital economy: aims, frameworks, pilots, results, and lessons. *Journal of Innovation and Entrepreneurship*, 9(16), 48–61. DOI: 10.1186/s13731-020-00129-1
7. Irtysheva, I. (2020). The effect of digital technology development on economic growth. *International Journal of Data and Network Science*, 48(4), 25–36. DOI: 10.5267/j.ijdns.2020.11.006
8. Malladi, C. M., Soni, R. K., Srinivasan, S. (2021). Digital financial inclusion: next frontiers—challenges and opportunities. *CSI Transactions on ICT*, 9(2), 127–134. DOI: 10.1007/s40012-021-00328-5
9. Miroslavskaya, M.V., Kozyrev, A.A. (2021). Digital economy as a tool for sustainable development. *Upravlencheskoye konsul'tirovaniye*, 147(3), 58–69. DOI: 10.22394/1726-1139-2021-3-58-69
10. Rincón-Moreno, J., Ormazábal, M., Jaca, C. (2021). Stakeholder perspectives in transitioning to a local circular economy: a case study in Spain. *EPJ Techniques and Instrumentation*, 10, 1–19. DOI: 10.1007/s43615-021-00098-x
11. Sorescu A., Schreier M. (2021). Innovation in the digital economy: a broader view of its scope, antecedents, and consequences. *Journal of the Academy of Marketing Science*, 3, 1–5, DOI: 10.1007/s11747-021-00793-z
12. Taburchak, A., Bychkova, S., Butina, A. (2019) Analysis of the development and implementation of applied projects in the digital economy. In proceedings of the Volgograd State University International Scientific Conference “*Competitive, Sustainable and Safe Development of the Regional Economy*” (CSSDRE 2019), 311–316. DOI:10.2991/cssdre-19.2019.62

Bibliometric Analysis of Central Bank Digital Currency Research

Ieva Turskytė

Vilnius University, Lithuania
E-mail: ieva.turskyte@evaf.stud.vu.lt
ORCID iD: 0000-0002-7320-8123

Alfreda Šapkauskienė

Vilnius University, Lithuania
E-mail: alfreda.sapkauskiene@evaf.vu.lt
ORCID iD: 0000-0002-0070-4097

Keywords: central bank digital currency, CBDC, bibliometric analysis

JEL code: E40, E50

Introduction

The topic of central bank digital currency (CBDC) became relevant after the announcement of the planned issuance of Diem cryptocurrency in 2019. Central banks and other financial institutions became concerned about monetary sovereignty and financial stability. This has led to a strong interest to fully explore the possibility of the emergence of CBDC and its implications for countries' monetary policy. With the rapid growth of scientific output in the research topic, it is important to perform a bibliometric analysis of the central bank digital currency research. The data scope of our research consists of 61 papers, extracted from the Web of Science database; the analysis was conducted via VOSviewer software. Our paper firstly focuses on the methodology, then we write about our data and results. Finally, we move on to the conclusion.

1. Methodology

In this paper we use bibliometric analysis with the aim to segregate the most popular CBDC research topic trends by conducting co-citation, bibliographic coupling, co-authorship and co-occurrence analysis. This paper works with the articles from Web of Science (WoS) for the 2016–2021 period. We selected all indexed papers with a compound of words “Central Bank Digital Currency” and the abbreviation “CBDC” included in the topic title. That brings a total of 61 publications that will be used in the analysis. The analysis was conducted through a bibliometric study using Visualisation of similarities (VOS) viewer software.

2. Data and results

The results showed that in 2018 there was only 5 Web of Science indexed CBDC publications; 2019 also did not have a significant increase of papers as the record count was 10. However, we see a vast increase in the number of published CBDC research papers. We explored the dynamics of published papers thorough the years and found that the most papers about CBDC were published in 2020-2021 period.

At the moment the most papers are published by authors from China, England and USA. The most contributing countries in terms of publications are one of the biggest world's states, resulting in a relatively higher number of researchers, thus the possibility of their interest in researching CBDC is more likely. In addition, the previously mentioned states' central banks at the moment are making pilot versions of CBDC or at least are doing extensive research. It leads to growing scientists' interest in the topic in the mentioned countries. It is also interesting to see the visual representation of countries' publications (Figure 1). For now the biggest countries (China, England, USA, Russia) involved in CBDC research are dominating the shared references.

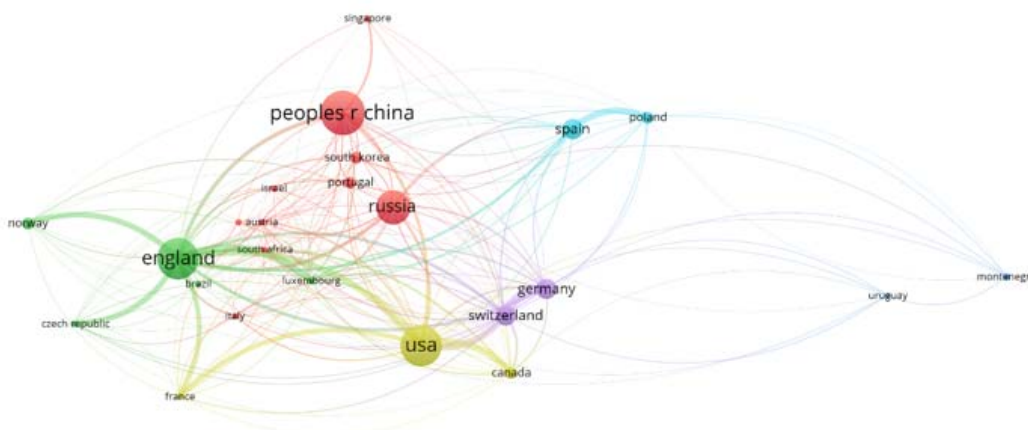

Figure 1. **Bibliographic coupling by country**

Source: compiled by authors

Among the top five publishers of CBDC related papers the most popular one is The China Economic Journal (or China Economic Review) with 6 publications; The Sustainability is also an important publication source with 4 publications of CBDC research; The IEEE Access and The Future Internet both equally published 3 papers from the CBDC research field. Both of the sources welcome multidisciplinary papers.

Bibliographic coupling analysis reveals that almost every paper is related in terms of citing the same references. The node which represents Fabris' (2019) paper "Cashless Society - The Future of Money or a Utopia?" is the biggest, meaning it is a publication which has the most shared references.

Moreover, we found the most cited articles by using co-citation analysis. The most cited article (in total 10 citations) is Nakomoto's "Bitcoin: A Peer-to-Peer Electronic Cash System". The second publication of Berentsen and Schar (2018), "The Case for Central Bank Electronic Money and the Non-case for Central Bank Cryptocurrencies", was also

cited 10 times. Further co-citation analysis reflect that the most cited authors or sources include European Central Bank (24 citations), Auer (22 citations), Bordo (19 citations), Kumhof (18 citations), and Tobin (18 citations).

Lastly, we explore which research papers are cited the most. The results suggest that Fabris' paper was the most popular citation; Brunnermeier's "On the equivalence of private and public money" was the second most cited source.

Conclusions

Our analysis indicates that the field of CBDC has not been deeply explored. However, the growing relevance of the topic has led to a dramatic increase in the number of scientific articles on the subject in recent years. We identified that the most scientific articles are written by the biggest world's economies. Also, the most favourable journals for CBDC publications are those of multidisciplinary kind. Given the overall picture of the study, the involvement of the investigating states in the high-quality CBDC analysis is largely visible; we also see that publications and authors have a weak link in terms of how many times authors cite each other. Finally, for the subsequent studies we recommend using CBDC research papers listed in several databases as it would widen the research scope.

References

1. Berentsen, A., Schar, F. (2018). The case for Central Bank Electronic Money and the non-case for Central Bank Cryptocurrencies. *Federal Reserve Bank of St. Louis Review*, 100(2), 97–106. <https://doi.org/10.20955/r.2018.97-106>
2. Brunnermeier, M.K., Niepelt, D. (2019). On the equivalence of private and public money. *Journal of Monetary Economics*, 106, 27–41. <https://doi.org/10.1016/j.jmoneco.2019.07.004>
3. Fabris, N. (2019). Cashless society – the future of money or a utopia? *Journal of Central Banking Theory and Practice*, 8(1), 53-66. <https://doi.org/10.2478/jcbtp-2019-0003>
4. Nakamoto, S. (2008). Bitcoin: a peer-to-peer electronic cash system. Available at: <https://bitcoin.org/bitcoin.pdf>

The Impact of the Level of Financial Inclusion on Ukraine's Economic Growth and Its Financial Security

Oleksandra Tverezovska

Sumy State University, Ukraine

E-mail: o.tverezovska@finance.sumdu.ua

ORCID iD: <https://orcid.org/0000-0002-0054-5575>

Larysa Hrytsenko

Sumy State University, Ukraine

E-mail: l.hrytsenko@finance.sumdu.ua

ORCID iD: <https://orcid.org/0000-0003-3903-6716>

Keywords: financial inclusion, financial security, Inclusive Development Index, economic development.

JEL code: O11, O47, F65.

Introduction

Ensuring financial security at all levels of government is an important issue for many countries, including Ukraine. Financial security is a dynamic process of financial relations, during which a favorable environment for economic growth and the necessary resources are created to improve the existing financial system to prevent internal and external threats. Over the past few years, the most dangerous threats to Ukraine's economic security are as follows: loss of production capacity, the annual increase in external debt, the danger of the country's transition to a state of the financial crisis; insufficient investment activity, low competitiveness of products on the foreign market, high level of poverty and critically low quality of life of most of the Ukrainian people, capital outflow. Moreover, nowadays an opportunity for future development of the financial inclusion process not only in Ukraine, but worldwide, greatly depends on the global crises of health COVID-19 pandemic caused by a coronavirus. The COVID-19 pandemic has a significant impact on the development of all areas and the financial sector was not an exception and was affected perhaps the most.

1. Financial inclusion as a driver for ensuring the financial security

In the current conditions of economic and political crises in Ukraine, the issue of ensuring financial security at various levels of the economic system comes to the fore from the finances of individual households to national finances. Analyzing the practical experience of developed countries, it can be argued that one of the main drivers of financial security may be the implementation of the principles of financial inclusion, which is to expand access of ordinary citizens, businesses to financial products and services, regardless of consumer status, age, activity, or place of residence.

Financial inclusion, accompanied by confidence in the financial and credit system by individuals and businesses, stimulates the direction of savings in the investment sphere, helps to reduce the shadow economy, increases the financial stability of economic entities, and consequently increases government revenues and financial security. The globalization of the economy, including financial globalization, has intensified the analysis of the issue of financial inclusion of society at the local and global levels.

2. Inclusive Development Index as an alternative to GDP in country's economic development measurement

Until now, in the theory and practice of public administration there was a statement that the level of economic development of countries can be analyzed by economic indicators, and especially by the indicator of gross domestic product (GDP). Although, it should be mentioned that in the modern condition of countries' development in the process of economic growth analysis huge attention should be paid not only to GDP, but also to the analysis of national priorities, which in turn cannot be included in the calculation of GDP.

As well as other economic indicators of development, GDP does not fully disclose the economic development of countries. Characterized by a purely economic indicator, GDP represents the totality of total consumption in the country, while avoiding such equally important criteria as the stratification of property, the educational system in the country and its environmental situation, the general satisfaction of the population with their standard of living. Focusing on the simplicity of GDP is a misleading idea of the economic situation, in addition to becoming a manipulative indicator for government officials. GDP is not able to fully cover the expansion of the digital, globalized economy, with a wide variety of goods and services; with companies operating abroad, it is difficult to accurately determine the degree of added value.

Therefore, now there is a problem with the creation of such a tool of analysis, which would fully allow the analysis of the economic situation in the country, identifying problems of social development while identifying their causes and further solutions. As an alternative to GDP, the indicator, which focuses on living standards was introduced in 2017 in Davos on the World Economic Forum (WEF).

In January 2017, the WEF in Davos (Switzerland) proposed the Inclusive Development Index (IDI), which experts say is an alternative to GDP and focuses on living standards.

IDI is based on 12 indicators, grouped into three groups of 4 separate quantitative indicators, which assess the level of economic development better than the GDP growth indicator. The three main parts of IDI are growth and development (including GDP growth, employment, labor productivity, and life expectancy); inclusiveness (median household income, poverty, and inequality); intergenerational justice and sustainability (level of savings, demographic burden, public debt, environmental pollution). The source of data for the formation of the Inclusive Development Index is mainly information from the World Bank, the International Labor Organization, the Organization for Economic Cooperation and Development.

WEF economists have divided 104 countries in the ranking format according to the indicator of inclusive development, dividing the countries into two groups - countries with advanced economies and those that are developing. The main indicator of such stratification into groups is the understanding of the concept of poverty and inequality in such

countries, which makes it impossible to implement them in a joint group. Therefore, it is not surprising that some developed countries (Sweden (6th place), Germany (12th place), Estonia (22nd place), Japan (24th place)) occupy lower positions than developing countries in their group (Lithuania (1st place), Azerbaijan (3rd place), Poland (5th place) (World Economic Forum, 2018). This difference can be explained by the methodology of this index, because, for example, Japan`s large foreign debt, which is the largest in the world, affects the country`s place in the ranking, even with high and stable GDP growth.

In addition to the above-mentioned classification in the ranking, there is another - on the growth trend of the Inclusive Development Index over the past 5 years. There are five following trends: 1) progressive; 2) slowly progressing; 3) stable; 4) slowly decreasing; 5) reducing. The first group since 2018 among developed countries are Iceland and Ireland, among the group of developing countries - Hungary, Latvia, Nepal, Macedonia, Georgia, Vietnam, Mongolia, Pakistan, Tajikistan, and India. Considering the negative trend of the index, in the first group this classification includes Finland, Slovenia and Spain, and among the second group - Ukraine, Mali and Mozambique. Ukraine, ranked 49th out of 74 possible, is the only European country with a declining inclusion index, whose inclusiveness has decreased by 6.8% in 5 years (World Economic Forum, 2018).

3. Problems and prospective directions of implementation of financial inclusion in Ukraine

Due to the distrust in financial institutions that emerged in the 1990s, the availability of illegal jobs in all sectors of the economy and the use of illegal or combined wage mechanisms, the motives for concealing income and liquidity in Ukraine, the level of financial inclusion is quite low. As we can see in the data that operations in consumer to business, business to business, business to consumer in Ukraine are mostly implemented not electronically (Table 1). At that time the well-developed countries or developing countries, which has a high level of financial inclusion (Japan, Poland, Cyprus) have already moved to the digital economy.

Table 1. Dynamics of individual indicators of financial inclusion

Indicator		Ukraine	Poland	Japan	Cyprus	Belarus
Sales (C2B)	electronically, %	19	42	63	43	25
	not electronically, %	81	58	37	57	75
Supplier payments (B2B)	electronically, %	44	65	82	68	49
	not electronically, %	56	35	12	32	51
Salary (B2C)	electronically, %	36	61	69	62	41
	not electronically, %	64	39	31	38	59

Source: compiled by authors based on Global Wealth Report, 2020

Ukraine has one of the highest levels of welfare inequality among all developing countries, but a relatively low level of income inequality and poverty. This is confirmed by the World Bank data (World Bank, 2021) according to which the Gini index of income in

Ukraine is one of the lowest in the world (26,6%) (for instance, in Lithuania such index is at the level of – 35,7%). In addition, Ukraine is remained one of the poorest countries in Europe with an average welfare of the average adult \$ 1,224 and the median level of well-being of one adult in Ukraine is even lower – \$133. For comparison, Zimbabwe's figures are \$3640 and \$1525 respectively (World Bank, 2021).

However, at present there is still a problem of cash in the shadow economy in Ukraine. Non-cash payments are the driver that can stimulate economic development, because cash payments are actually a shadow economy, and non-cash payments are something that can fill the budget in the future and be an incentive for business to develop, because there is an understanding of where money goes flows as they go, as controlled; the population has an understanding of how to manage their flows, there is a greater tendency to save. Cash is difficult to keep track of where it functionates, to whom and for what purpose, and how it is then taxed. For government officials, the shift from cash to digital payments can reduce corruption and increase efficiency.

In the period of independence and state building in Ukraine underdevelopment of financial institutions, the spread of fraud with privatization securities in the period of small and large privatization dollarization of the economy, the formation of corruption and raiding mechanisms, the creation of oligarchic conglomerates, intensification of foreign investment, including for money laundering, the development of raiding through criminal, law enforcement and judicial mechanisms, the weakness of control institutions, political instability, the economic crisis have led to the growth of the informal and illegal sectors of the economy, the spread of crime, including namely criminal and quasi-criminal methods of initial capital accumulation.

According to preliminary calculations of the Ministry of Economy of Ukraine (MEF, 2021), the level of the shadow economy in January-March 2021 was 30% of official GDP, which is 1 percentage point less than the corresponding period of 2020, and only 2 percentage point less than the corresponding before pandemic period of 2018. The slight decrease in the level of the shadow economy took place against the background of adaptation of economic entities to the permanent conditions of quarantine restrictions, which have lasted for more than a year. This is confirmed by the improvement in the reporting period (compared to January-March 2020) of the financial results of enterprises and the expression of optimistic business sentiment in the expectations of business activity of enterprises in response to favorable external conditions and increasing domestic demand.

Comparing the indicators according to the State Statistics Service of Ukraine for the last 8 years, the level of the shadow economy within 30% is the lowest indicator, while in 2014 it reached 43% (State Statistics Service of Ukraine, 2021). Therefore, today the de-shadowing of the economy is a manifestation of the effectiveness of reforms and their perception by society. But still its level remains high.

Under conditions of devaluation of labor, honesty, spread of solving all problems only for money and other forms of bribery, bribes, etc., the level of perception of corruption has significantly improved: the country's position on this indicator in the ranking deteriorated during 2012–2018 (from 142 to 120) a slow improvement of the situation, but in 2019 it increased to 126, and according to the 2020 data the Ukraine rank of perception of corruption decreased to 117. For instance, Lithuanian was at the 38 place in 2018 and at the 35 place in 2020 (Corruption perceptions Index, 2021).

Corruption in Ukraine is facilitated by the complexity of the national socio-economic system, high level of employment in the budget sphere, inconsistency of institutional and

economic mechanisms in health care and education with the new economic conditions, low level of culture of responsibility in business and domestic behavior, weakness of civil society in control law enforcement system.

Conclusions

1. One of the keyways to ensure financial security in Ukraine is the introduction of the principles of financial inclusion. Financial inclusion, combined with public and business confidence in the financial and credit system, stimulates the direction of savings in the investment sphere, reducing the shadowing of the economy, increasing financial stability of economic entities, improving monetary policy and financial stability and as a result increasing the level of state revenues and ensuring financial security
2. Inclusive Development Index can be implemented as an alternative to the GDP in the economic development measurement.
3. There is a significant lag in the level of financial inclusion in Ukraine in comparison with the leading countries of the world. This contributes to the spread of shadow schemes in the economy, capital outflows, shortfalls in budget revenues, and ultimately reduce the financial security of our country.
4. According to the abovementioned facts, Ukrainian government must actively work in its political and legislative activities in the segment of the financial system. There is a direct relationship between the level of public involvement in financial services, its financial inclusion and financial security.

References

1. Ministry of Economy of Ukraine (2021). *General trends of the shadow economy in Ukraine in the first quarter of 2021*. Available at: <https://me.gov.ua/old/?lang=en-GB>
2. Research Institute. *Global Wealth Report 2020 (2021)*. Available at: <https://www.credit-suisse.com/about-us/en/reports-research/global-wealth-report.html>
3. State Statistics Service of Ukraine (2021). *Shadow economy index*. Available at: <http://www.ukrstat.gov.ua>
4. Transparency International. *Corruption perceptions Index (2021)*. Available at: <https://www.transparency.org/en/cpi/2020/index/nzl>
5. World Bank (2021). *Financial inclusion*. Available at: <https://www.worldbank.org/en/topic/financialinclusion>
6. World Economic Forum. *The Inclusive Development Index 2018 (2018)*. Available at: <https://www.weforum.org/reports/the-inclusive-development-index-2018>.

Relationship Between Healthcare Spendings and Life Expectancy in the USA

Aurelija Ulbinaitė

Vilnius University, Lithuania
E-mail: aurelija.ulbinaite@ef.vu.lt
ORCID iD: 0000-0001-5025-7240

Ramūnas Radzevičius

Vilnius University, Lithuania
E-mail: ramunas.radzevicius@evaf.stud.vu.lt
ORCID iD: 0000-0002-2102-1252

Keywords: healthcare spending, GDP, life expectancy, population's health.

JEL code: I10, I18, I19.

Introduction

Life expectancy in the USA is one of the lowest among the developed countries (46th out of 191), namely 79.11 years in 2021 (Worldometer, 2021); however, their spending on healthcare was the highest in the world (1st out of 191) in 2019 (OECD, 2019). On the one hand, Hawaii, California, Minnesota, and New York had 82, 81.3, 81, and 81 years of life expectancy, respectively, in 2015 (Kaiser Family Foundation, 2015). This is comparable to the top 30 countries' life expectancy: Hong Kong (No. 1, 85.29 years in 2021) and Japan (No. 2, 85.03 years in 2021) (Worldometer, 2021). Japan took the 15th place in the world by spending on healthcare in 2019 (OECD, 2019), 28th place for GDP per capita in 2017, and 3rd place in overall GDP in the world in 2017 (Worldometer, 2017). On the other hand, Mississippi and West Virginia had a life expectancy of 74.9 and 75.3 years in 2015 (Kaiser Family Foundation 2015). This is comparable to Guatemala, Jordan, and Jamaica which have 75.05, 75.01, and 74.88 years of life expectancy, 94th, 95th, and 96th place, respectively, in the world in 2021 (Worldometer, 2021).

Mississippi took the 34th place and West Virginia the 12th place on spending on healthcare in 2014 (Kaiser Family Foundation, 2014). Hawaii was 41st for spending on healthcare, California 37th, Minnesota 15th, and New York 8th in 2014 (Kaiser Family Foundation, 2015).

The above data shows that the amount of money spent on healthcare is not correlated with better health and higher life expectancy. There are some underlying factors that cause better or worse health, or lower or higher life expectancy. A better indicator is GDP; there is a correlation between GDP by state and corresponding life expectancy. However, there are still some discrepancies. E.g., Mississippi was 37th by GDP per capita, West Virginia 42nd, Hawaii 39th, California 1st, Minnesota 18th, New York 3rd in 2020 (Statista 2020). The USA's GDP was 13th per capita in 2017 and was the highest GDP overall in the world in 2017 (Worldometer, 2017).

The presented data raises the question of why there is such a low life expectancy in the USA.

The problem is that the USA's leading causes of death are the following: heart disease, cancer, accidents (unintentional injuries), chronic lower respiratory diseases, stroke, Alzheimer's disease, diabetes, nephritis, nephrotic syndrome, and nephrosis, influenza and pneumonia, intentional self-harm (suicide) (Centers for Disease Control and Prevention 2021). However, in the world overall, the leading causes of death are different: ischemic heart disease, stroke, chronic obstructive pulmonary disease, lower respiratory infections, neonatal conditions, trachea, bronchus, lung cancers, Alzheimer's disease, and other dementias, diarrheal disease (Statista 2020). Looking at these data, it is apparent that there are more cancer cases in the USA (which might be due to vigorous testing). However, the USA has fewer stroke deaths than the rest of the world. Also, the top 1% of income earners in the USA have the highest life expectancy in the world (Chetty et al., 2016).

Moreover, the population's health is affected by the level of education and level of income. The higher the income level the better is the health of the individual. The same applies to education, i.e., the higher the education level the better is the health of the person. However, if a person only has a high school degree and lives in an area next to highly educated individuals, then life expectancy of that person increases.

Furthermore, it seems that healthcare is not at fault regarding low life expectancy in the USA since there are more people being tested for cancer than in Europe, and more aggressive treatments are prescribed in the USA (Preston, Ho, 2009). Percentagewise, more people survive cancer in the USA than in Europe (Preston, Ho, 2009).

There are 91.4% of people covered by any health insurance in the USA (Statista, 2021). This raises the main research question of why spending more on healthcare and having the high GDP in the USA does not correlate to higher life expectancy.

Theoretical insights

Some studies have been carried out about this issue. Some authors (Sasson, 2016; Chetty et al., 2016) state that life expectancy in the USA is affected by income, educational attainment, and nature of diseases, their detection, and treatment.

Low-income individuals live longest in affluent cities next to high-income individuals such as New York City, New York, and San Francisco, California (Chetty et al., 2016). There could be many explanations why low-income individuals live longer in affluent cities next to highly educated individuals (Chetty et al., 2016). It could be that these areas restrict smoking and there is more funding for public services (Chetty et al., 2016). Low-income individuals could be also influenced by individuals who behave in a healthier way (Chetty et al., 2016). Death records were obtained from Social Security Administration (Chetty et al., 2016).

College-educated Americans have lower mortality rates and higher life expectancy than less-educated Americans (Hummer, Lariscy, 2011). Non-Hispanic whites that have less than 12 years of education have absolute declines in life expectancy (Olshansky et al., 2012). The widening life expectancy gap between higher educated Americans and lower educated Americans is alarming and is being questioned by scholars what the cause is (e.g., Behrman et al., 2011). Scholars have emphasized that each additional year of education adds years to

life expectancy (Montez et al., 2012). Data was gathered from the National Vital Statistics System and the US Multiple Cause of Death public use files (Sasson, 2016).

Other authors also state that less educated, and lower income individuals have lower life expectancy in the USA, and it worsened due to COVID-19 pandemic (Venkataramani et al., 2021).

Trends in obesity adversely affect the USA's population's health (OECD 2008; Cutler, Glaeser and Shapiro, 2003). The USA has more cases of diseases than Europe in cancer, cardiovascular diseases, and diabetes (Thorpe et al., 2007a; Avendano et al., 2009). More disease cases might show that there is better detection of diseases and longer survival which shows better treatment (Preston, Ho, 2009). High survival rates show that treatment is very successful or that diseases have been detected early (Preston, Ho, 2009). Early detection of disease allows better treatment (Preston, Ho, 2009). E.g., various data show that tumours are earlier diagnosed in the USA than in Europe (Gatta et al., 2000; Sant et al., 2004; Ciccolallo et al., 2005).

The high USA's spending on healthcare could be partially explained by the fact that Americans had the most visits to doctors; they are first to innovate in medical technology and by volume of technology such as magnetic resonance imaging (MRI) and computerized tomography (CT) units (Anderson et al., 2000).

Conclusions

In short, life expectancy in the USA depends on its population's educational attainment and income. Also, life expectancy is impacted by smoking, physical inactivity, obesity, which in turn may cause lung cancers, diabetes, heart diseases, and strokes. It does not appear that poor healthcare performance is a factor that causes low life expectancy. If anything, the USA healthcare does perform quite well since successfully treated cancer cases are higher in the USA than in Europe. This can be due to the fact that the USA tests for cancers more vigorously. Moreover, cancer survival rates are higher in the USA than in Europe; it can also be explained by the more aggressive treatment in the USA. In addition, some of the reasons that healthcare is so expensive in the USA is that they use newer technologies and there are more hospital beds and primary care physicians. Furthermore, testing for diseases is more vigorous using MRI and CT scans.

References

1. Anderson, G. F., Hurst, J., Sotir Hussey, P., Jee-Hughes, M. (2000). Health spending and outcomes: trends in OECD countries, 1960–1998. *Health Affairs*, 19(3). <https://doi.org/10.1377/hlthaff.19.3.150>
2. Avendano, M., Glymour, M., Banks, J., Mackenbach, J. P. (2009). Health Disadvantage in US Adults Aged 50 to 74 Years: A Comparison of the Health of Rich and Poor Americans With That of Europeans. *American Journal of Public Health*, March. Available at: <https://ajph.aphapublications.org/doi/full/10.2105/AJPH.2008.139469>
3. Behrman, J. R., Kohler, H.-P., Jensen, V. M., Pedersen, D., Petersen, I., Bingley, P., Christensen, K. (2011). Does more schooling reduce hospitalization and delay mortality? New evidence based on Danish twins. *Demography*, November, 48(4), 1347–1375. <https://dx.doi.org/10.1007%2Fs13524-011-0052-1>
4. Centers for Disease Control and Prevention. (2021). *FASTSTATS - leading causes of death*. March 1. Available at: <https://www.cdc.gov/nchs/fastats/leading-causes-of-death.htm>

5. Chetty, R., Stepner, M., Abraham, S., Lin, S., Scuderi, B., Turner, N., Cutler, D. (2016). The Association between income and life expectancy in the United States, 2001-2014. *JAMA*, 315(16), 1750–1766. <https://doi.org/10.1001/jama.2016.4226>
6. Ciccolallo, L., Capocaccia, R., Coleman, M. P., Berrino, F., Coebergh, J. W. W.; Damhuis, R. A. M., Faivre, J., Martinez-Garcia, C., Møller, H., Ponz de Leon, M., Launoy, G., Raverdy, N., Williams, E. M. I., Gatta, G. (2005). Survival differences between European and US patients with colorectal cancer: Role of stage at diagnosis and surgery. *Gut*, 54(2), 268–73. <https://doi.org/10.1136/gut.2004.044214>
7. Cutler, D. M., Glaeser, E. L., Shapiro, J. M. (2003). Why have Americans become more obese? *Journal of Economic Perspectives*, 17(3), 96–118. Available at: <https://pubs.aeaweb.org/doi/pdfplus/10.1257/089533003769204371>
8. Elflein, J. (2021). *Topic: Health insurance in the U.S.* Statista. Available at: https://www.statista.com/topics/7807/health-insurance-in-the-us/#dossierSummary__chapter2.
9. Gatta, G., Capocaccia, R., Coleman, M. P., Ries, L. A. G., Hakulinen, T., Micheli, A., Sant, M., Verdecchia, A., Berrino, F. (2000). Toward a comparison of survival in American and European cancer patients. *American Cancer Society Journals*, 89(4), 893–900. Available at: [https://acsjournals.onlinelibrary.wiley.com/doi/pdf/10.1002/1097-0142\(20000815\)89:4%3C893::AID-CNCR24%3E3.0.CO;2-9](https://acsjournals.onlinelibrary.wiley.com/doi/pdf/10.1002/1097-0142(20000815)89:4%3C893::AID-CNCR24%3E3.0.CO;2-9).
10. *Health resources - health spending - oecd data.* (2019). Available at: <https://data.oecd.org/healthres/health-spending.htm>.
11. Hummer, R. A., Lariscy, J. (2011). Educational attainment and adult mortality. In book: *International Handbook of Adult Mortality*. Publisher: Springer. http://dx.doi.org/10.1007/978-90-481-9996-9_12
12. Kaiser Family Foundation (2017). *Health care expenditures per capita by the state of residence.* Available at: Available at: <https://www.kff.org/other/state-indicator/health-spending-per-capita/?currentTimeframe=0&sortModel=%7B%22colId%22%3A%22Health+Spending+per+Capita%22%2C%22sort%22%3A%22desc%22%7D>.
13. Kim, T. K., Lane, S. R. (2013, September). Government health expenditure and public health outcomes: a comparative study among 17 countries and implications for US Health Care Reform. *American International Journal of Contemporary Research*, 3(9), 8–13. Available at: http://www.aijcrnet.com/journals/Vol_3_No_9_September_2013/2.pdf
14. Montez, J. K., Zajacova, A. (2013). Explaining the widening education gap in mortality among U.S. white women. *Journal of health and social behavior*, 54(2), 166–182. <https://doi.org/10.1177/0022146513481230>
15. OECD. Organisation for Economic Co-operation and Development (2008). *OECD Health Data 2008: How Does the United States Compare?*
16. Olshansky, J., Antonucci, T., Berkman, L., Binstock, R. H., Boersch-Supan, A., Cacioppo, J. T., Carnes, B. A., Carstensen, L. L., Fried, L. P., Goldman, D. P., Jackson, J., Kohli, M., Rother, J., Zheng, Y., Rowe, J. (2012). Differences in life expectancy due to race and educational differences are widening, and many may not catch up. *Health Affairs (Millwood)*, 31, 1803–13. Available at: 2011-0746 1803..1813 (ucsf.edu)
17. Olshansky, J., Passaro, D. J., Hershow, R. C., Layden, J., Carnes, B. A., Brody, J., Hayflick, L., Butler, R. N., Allison, D. B., Ludwig, D. S. (2005). A potential decline in life expectancy in the United States in the 21st Century. *The New England Journal of Medicine*, 352(11), 1138–45. Available at: <https://www.nejm.org/doi/full/10.1056/NEJMr043743>
18. Preston, S. H., Ho, J. Y. (2009). Low life expectancy in the United States: is the health care system at fault? *Working Paper 15213*. Available at: https://www.nber.org/system/files/working_papers/w15213/w15213.pdf.
19. Sant, M., Allemani, C., Berrino, F., Coleman, M. P., Aareleid, T., Chaplain, G., Coebergh, J. W., Colonna, M., Crosignani, P., Danzon, A., Federico, M., Gafa, L., Grosclaude, P., Hedelin, G.; Mace' -Lesech, J.; Martinez Garcia, C.; Møller, H.; Paci, E.; Raverdy, N., ... Williams, E. M. I. (2003). Breast carcinoma survival in Europe and the United States. *Cancer*. 100(4), 715–722. <https://doi.org/10.1002/cncr.20038>.
20. Sasson, I. (2016). Trends in life expectancy and Lifespan variation by educational Attainment: United States, 1990–2010. *Demography*, 53, 269–293. <https://doi.org/10.1007/s13524-015-0453-7>.

21. Statista (2020). *Infographic: The World's leading causes of death*. Available at: from <https://www.statista.com/chart/23755/total-number-of-people-who-died-from-the-following-conditions/>
22. Statista. (2020). *U.S.: GDP per capita by state in 2018*. Available at: <https://www.statista.com/statistics/248063/per-capita-us-real-gross-domestic-product-gdp-by-state/>.
23. Statista. (2021). *U.S. real gross domestic product (GDP) by State 2020*. Available at: <https://www.statista.com/statistics/248053/us-real-gross-domestic-product-gdp-by-state/>.
24. Thorpe, K. E.; Howard, D. H., Galactionova, K. (2007). Differences in disease prevalence as a source of the U.S.-European health care spending gap. *Health Affairs*. 26(2). <https://doi.org/10.1377/hlthaff.26.6.w678>.
25. Venkataramani, A. S., O'Brien, R., Tsai, A. C. (2021). Declining Life Expectancy in the United States The Need for Social Policy as Health Policy. *JAMA*, 325(7), 621–622. <https://doi:10.1001/jama.2020.26339>.
26. Worldometer. (2017). *Gdp by country*. Available at: <https://www.worldometers.info/gdp/gdp-by-country/>.
27. Worldometer. (2020). *Life expectancy of the world population*. (2020). Available at: <https://www.worldometers.info/demographics/life-expectancy/>.

How Social Business Sustainability Relates to Consumer Purchase Decision

Aurelija Ulbinaitė

Vilnius University, Lithuania
E-mail: Aurelija.Ulbinaite@ef.vu.lt
ORCID iD: 0000-0001-5025-7240

Neringa Raštutytė

Vilnius University, Lithuania
E-mail: neringa.rastutyte@evaf.stud.vu.lt

Keywords: social business, sustainability, system transformation, consumer behaviour.

JEL code: Q56, D11, O44.

Introduction

Despite its positive results, social business is continuously criticised for its inability to contribute effectively to sustainable development practices. Researchers have extensively addressed the concept of sustainability in the scientific literature (Donaldson, Walsh, 2015; Dyllick, Muff, 2016; Upward, Jones, 2016). They define the importance of not only the participation of organisations in sustainable development but also highlight the importance of society as another participant (Ketprapakorn, Kantabutra, 2019). Moreover, studies show that consumers' intention to purchase sustainable products or services is strongly influenced by their positive attitudes and perceived value of sustainability (Rizwan, Ahmad, Mehboob, 2013; Vazifehdousta, 2013). The state of the art allows stating that sustainability as an aspiration is still a priority but remains only in its early maturity stages.

1. Sustainability in social business organizations and consumer behaviour

Management is an important aspect for organisations' effort to develop sustainability. Therefore, sustainability and its assessment become an essential component of corporate performance management (Saeed, Kersten, 2017). This implies that to develop sustainability more effectively, it is also necessary to analyse public attitudes towards sustainability. Thus, it is important to acknowledge the need for examining existing boundaries and recognise the dependence of organisations on societal, economic, and environmental aspects (Meadows et al., 2009; Rockstrom et al., 2009; Marcus et al., 2010; Whiteman et al., 2013; Winn, Pogutz, 2013). Research shows that while companies recognise the importance of sustainability, a large proportion do not pay attention to practical sustainability management (Bonini et al., 2010). For achieving a positive change, sustainability management should become one of the key processes when improving company performance.

Research also shows that changes in the environment are influencing consumer perceptions and that the concept of sustainability is becoming increasingly important to consum-

ers (Bonini, Oppenheim, 2008). Moreover, knowledge about sustainability is an essential factor influencing the purchase of sustainable products (Franzen, Meyer, 2010; Sidique, Lupi, Joshi, 2010; Arslan, Yilmaz, Aksoy, 2012; Vega-Zamora, et al., 2013; Paul, Modi, Patel, 2016; Yadav, Pathak, Young, 2016). The scientific literature distinguishes the theory of reasoned action and the theory of planned behaviour (Fishbein, M., 1979; Ajzen, I., 1991). The main aspects of the theory are that consumer behaviour is influenced by intention, attitudes towards a certain behaviour, subjective norm, and perceived behavioural control. Research shows that consumers' intention to purchase sustainable products or services is strongly influenced by positive attitudes and perceived value of sustainability (Rizwan, Ahmad, Mehboob, 2013; Vazifehdosta, 2013). Hence, knowledge about sustainability and its value plays an important role for sustainability to flourish.

2. Theoretical framework of interaction between social business sustainability and consumer purchase behaviour

To develop sustainability, the whole ecosystem around businesses, together with the businesses themselves, needs to transform. The analysis of the corporate perspective allows distinguishing three dimensions of sustainability, which require identifying corresponding indicators. The development of the first dimension, i.e., economic dimension, is a relevant aspect of sustainability development, and when analysing it, it is crucial to analyse areas such as the stability and profitability of organisations, the distribution of income, the market advantage, or the costs of sustainability development. The second dimension, i.e., social dimension, focuses on human rights and anti-corruption and related measurements, human resources, public health and safety, training and education, as well as analysing consumer issues and compliance with social norms. However, the social dimension is still the most challenging dimension to assess and needs to be monitored and analysed more deeply. The third dimension i.e., environmental dimension, is also an important one which helps to highlight energy and material efficiency, correct water management, waste management, measurement of emissions, the use of land as a critical resource, compliance with environmental requirements and the evaluation of suppliers (Saeed, Kersten, 2017).

In this paper, we come up with a conceptual framework that focuses on a broader analysis of sustainability, going beyond the perspective of companies or consumers only, but involving both participants in the process. The exploration and assessment of the aforementioned dimensions of sustainability influence the consumers' inclination to value sustainability, which in turn influences the consumers' purchasing behaviour such as the purchase of more sustainable products/services, or influences the choice of sustainable social business.

Conclusions

The scientific research analysis shows that to achieve economically, socially, and environmentally sustainable development, it is necessary to analyse not only the ability of companies to act sustainably, but also the contribution of consumers to sustainability by analysing their inclination to assess sustainability and their purchasing behaviour related to it.

References

1. Ajzen, I. (1991). The theory of planned behavior. *Organizational Behavior and Human Decision Processes*, 50, 179–211. [http://dx.doi.org/10.1016/0749-5978\(91\)90020-T](http://dx.doi.org/10.1016/0749-5978(91)90020-T)
2. Arslan, T., Yilmaz, V., Aksoy, H. (2012). Structural equation model for environmentally conscious purchasing behavior. *International Journal of Environmental Research*, 6(1), 323–334. Available at: https://ijer.ut.ac.ir/article_498_456e2e6b5052ddb282b0d584e460cb4.pdf
3. Bonini, S., Görner, S., Jones, A. (2010). How companies manage sustainability. *McKinsey Global Survey Results*, New York, NY. Available at: <https://www.mckinsey.com/business-functions/sustainability/our-insights/how-companies-manage-sustainability-mckinsey-global-survey-results>
4. Bonini, S.M., Oppenheim, J.M. (2008). Cultivating the green consumer. *Stanford Social Innovation Review*, 56–61. https://ssir.org/articles/entry/cultivating_the_green_consumer#
5. Donaldson, T., Walsh, J.P. (2015). Toward a theory of business. *Research in Organizational Behavior*, 35, 181–207. <http://dx.doi.org/10.1016/j.riob.2015.10.002>
6. Dyllick, T., Muff, K. (2016). Clarifying the meaning of sustainable business: introducing a typology from business-as-usual to true business sustainability. *Organization & Environment*, 29(2), 156–174. <https://doi.org/10.1177%2F1086026615575176>
7. Fishbein, M. (1979.) A theory of reasoned action: Some applications and implications. *Nebraska Symposium on Motivation*, 27, 65–116.
8. Franzen, A., Meyer, R. (2010). Environmental attitudes in cross-national perspective: A multi-level analysis of the ISSP 1993 and 2000. *European Sociological Review*, 26(2), 219–234. <https://doi.org/10.1093/esr/jcp018>
9. Ketprapakorn, N., Kantabutra, S. (2019). Sustainable social enterprise model: relationships and consequences. *Sustainability*, 11(14), 3772. <https://doi.org/10.3390/su11143772>
10. Marcus, J., Kurucz, E.C., Colbert, B.A. (2010). Conceptions of the businesses society nature interface: implications for management scholarship. *Business and Society*, 49(3), 402–438. <https://doi.org/10.1177%2F0007650310368827>
11. Meadows, D., Rockstrom, J., Steffen, W., Noone, K., Persson, A., Chapin, F.S., Lambin, E.F., Foley, J.A. (2009). A safe operating space for humanity. *Nature*, 461, 472–475. <https://doi.org/10.1038/461472a>
12. Paul, J., Modi, A., Patel, J. (2016). Predicting green product consumption using theory of planned behavior and reasoned action. *Journal of Retailing and Consumer Services*, 29, 123–134. <https://doi.org/10.1016/j.jretconser.2015.11.006>
13. Rizwan, M., Ahmad, S.U., Mehboob, N. (2013). Enhancing the green purchase intention based on green marketing: an empirical study from Pakistan. *Asian Journal of Empirical Research*, 3(2), 208–219. <https://ideas.repec.org/a/asi/ajoerj/2013p208-219.html>
14. Rockström, J., Steffen, W. L., Noone, K. et al. (2009). Planetary boundaries: exploring the safe operating space for humanity. *Ecology and Society*, 14(2), 32. <https://www.ecologyandsociety.org/vol14/iss2/art32/>
15. Saeed, M.A., Kersten, W. (2017). Supply chain sustainability performance indicators: A content analysis based on published standards and guidelines. *Logistics Research*, 10(12), 1–19. http://dx.doi.org/10.23773/2017_12
16. Sidique, S.F., Lupi, F., Joshi, S.V. (2010). The effects of behavior and attitudes on drop-off recycling activities. *Resources, Conservation and Recycling*, 54(3), 163–170. <https://doi.org/10.1016/j.resconrec.2009.07.012>
17. Upward, A., Jones, P. (2016). An ontology for strongly sustainable business models: defining an enterprise framework compatible with natural and social science. *Organization & Environment*, 29, 97–123. <https://doi.org/10.1177%2F1086026615592933>
18. Vazifehdosta, H. (2013). Purchasing green to become greener: factors influence consumers' green purchasing behavior. *Management Science Letters*, 3, 2489–2500. <https://doi.org/10.5267/j.msl.2013.08.013>
19. Vega-Zamora, M., Parras-Rosa, M., Murgado-Armenteros, E.M., Torres-Ruiz, F.J. (2013). A powerful word: the influence of the term 'organic' on perceptions and beliefs concerning food. *International Food and Agribusiness Management Review*, 16(4), 1–26. <https://doi.org/10.22004/ag.econ.159660>

20. Whiteman, G., Walker, B., Perego, P. (2013). Planetary boundaries: ecological foundations for corporate sustainability. *Journal of Management Studies*, 50(2), 307–336. <https://doi.org/10.1111/j.1467-6486.2012.01073.x>
21. Winn, M.I., Pogutz, S. (2013). Business, ecosystems, and biodiversity: new horizons for management research. *Organization and Environment*, 26(2), 203–229. <https://doi.org/10.1177%2F108602661349017>
22. Yadav, R., Pathak, G.S. (2016). Young consumers' intention towards buying green products in a developing nation: Extending the theory of planned behavior. *Journal of Cleaner Production*, 135, 732–739. <https://doi.org/10.1016/j.jclepro.2016.06.120>

Industrial Waste Accounting at the Life-Cycle Stages in the Concept of Green Economy

Svetlana Vejera

Polotsk State University, Belarus

E-mail: s.vejera@psu.by

ORCID iD: orcid.org/0000-0002-5717-6109

Volha Sushko

Polotsk State University, Belarus

E-mail: o.sushko@psu.by

ORCID iD: orcid.org/0000-0001-5036-2200

Keywords: green economy, industrial waste, waste accounting, life-cycle stages.

JEL code: M, M4, M41.

Introduction

The presence of problems both in the economy and in the environment has become a starting point for finding solutions aimed at creating a sustainable economy that goes beyond the usual growth strategies (Bina; La Camera, 2011; Test of the OECD..., 2013, Hertwich, Peters, 2009). A green economy has become a promising strategy, and the international community has officially recognized at the end of the 2012 Rio + 20 summit that a green economy can enhance the ability of companies to manage natural resources sustainably and reduce environmental impact, improve resource efficiency and reduce waste. Today, the most pressing problems, according to the concept of a green economy, are the intensive accumulation of industrial waste, the problem of their use and disposal (Towards a green economy..., 2011), which contributes to environmental degradation and depletion of the mineral resource base. In this regard, the need to reduce harmful effects on the environment by dramatically improving waste management and rational nature management is of great importance. Thus, the priority areas for ensuring environmental protection, rational use of natural resources, environmental safety and the transition to a “green” economy are:

1. reduction of the volume of waste generation;
2. sustainable consumption and production;
3. maximum involvement of waste as secondary raw materials;
4. Prevention of harmful effects of waste on the environment.

For the Republic of Belarus, within the framework of the designated priority areas, the most urgent problem is industrial waste, in view of the fact that they account for about 86% of the total volume of generated production waste, which confirms the relevance of the research topic.

The purpose of the study is to develop an industrial waste accounting system. Research tasks are the following: - identifying the life cycle stages of the industrial waste for accounting purposes; - definition of industrial waste as objects of accounting; - development of

approaches to the assessment of industrial waste. The object of research is industrial waste at the life cycle stages. Among the methods used in the study, the authors identify synthesis, analysis, comparison, logical generalization, inference by analogy, etc.

1. Life-cycle stages of industrial waste

As part of the development of the “green” economy in the Republic of Belarus, the transformation of the existing accounting system for the formation of information arrays of a fundamentally new qualitative level, reflecting the close relationship between the resources of the natural environment and the results of the economy for making management decisions in the field of rational environmental management, is of great importance.

To transform the accounting system for rational environmental management in the context of a green economy, it is necessary to consider industrial waste within the life cycle, highlighting the following stages:

- I. “The emergence of industrial waste”;
- II. “Collection and / or accumulation of industrial waste”;
- III. “Industrial waste recycling”;
- III¹ “Preparation for the use of industrial waste”;
- III² “Storage of industrial waste”;
- III³ “Use of industrial waste”;
- IV “Burial of industrial waste”.

This will make it possible to track industrial waste from the moment of its formation to the moment of its disposal in order to manage it competently in the context of the principles of a green economy.

2. Industrial waste as an object of accounting

To date, industrial waste as an accounting object is not reflected in the accounting system, which does not allow tracking them at all the life cycle stages in order to make effective decisions on the rational use of natural resources. In this regard, a new object of accounting and reporting is proposed - industrial waste, which is economic resources that have completely or partially lost their consumer properties, formed in the course of the organization's production activities, but not being the goal of the production process.

Unlike the existing approach, which presupposes the presence of disparate accounting objects (recyclable waste, secondary material resources, secondary raw materials, a by-product) with different approaches to assessing these objects and, as a result, incomplete reflection of information on waste in the accounting and reporting of enterprises, this is will allow to form a reliable information base on industrial waste, presented in accounting and reporting at all the life cycle stages of industrial waste in order to manage the economic and environmental safety of industrial enterprises in the context of the principles of a “green” economy.

3. Industrial waste assessment for accounting purposes

To develop a comprehensive methodology for accounting for industrial waste at the life cycle stages, it is necessary to determine approaches to the assessment of industrial waste at the life cycle stages. The essence of this approach, according to the authors, will be to reflect industrial waste in two assessments:

1. First, at fair value using account XX "Industrial waste" in the context of various types of industrial waste, such as: 1) waste arising from tank cleaning; 2) construction waste; 3) waste of ferrous and non-ferrous metals; 4) irrecoverable waste and others. Reflecting industrial waste at a fair value in the life cycle will help to assess their economic potential - in contrast to the existing approach, during which a high cost of waste is formed by mixing two types of assessment: at actual costs and at current market prices - which will reduce demotivation industrial enterprises to involve industrial waste in recycling, reduce the accumulation of hazardous waste in open areas and reduce the risks of developing a hidden waste market.
2. Secondly, according to the actual costs of collection, accumulation, recycling and disposal of industrial waste using account YY "Cost of handling industrial waste" and further writing off to the account "Other income and expenses" waste, which will not only contribute to the systematic grouping of costs for the purposes of managing the activities of petrochemical enterprises in terms of industrial waste management at the micro level and assessing choosing to recycle industrial waste in the context of green economy principles. The types of industrial waste assessment used will make it possible to generate at each stage of the life cycle of industrial waste information about two management objects: the cost of waste management and potential income from their use, providing the information need of various users of accounting (financial) statements in the areas of interest to them, increasing the information value reporting and its forecast characteristics.

Conclusions (recommendations, debatable issues)

Thus, for a new accounting object, we propose a new approach to its assessment. We propose to reflect the economic potential of industrial waste in accounting as follows:

1. The fair value of industrial waste should be reflected on the debit of the proposed active account XX "Industrial waste" and the credit of the accounts "Investments in long-term assets", "Materials", "Cost of production", etc.
2. Changes in the fair value of industrial waste due to changes in the physical properties of processed industrial waste and possible technological losses are attributed to XX "Industrial waste" and "Other income from current activities" or "Other expenses from current activities".
3. The costs arising at the life cycle stages associated with the implementation of a set of measures for the management of industrial waste should be taken into account separately from industrial waste reflected in account XX "Industrial waste".

We suggest organizing the accounting of the cost of industrial waste management as follows:

1. The cost of industrial waste management as part of the actual costs of collection, accumulation, recycling and disposal of industrial waste should be reflected separately from industrial waste on the proposed active account ZZ "Waste management cost".

2. The cost of handling industrial waste should be reflected as part of the current period's expenses and written off to the debit of the account "Other expenses on current activities" with the allocation of the sub-account "Expenses on handling industrial waste" in the share attributable to this reporting period.

These proposals will contribute to the formation of reliable data in the accounting system, increase the information value of accounting (financial) reporting indicators, correct interpretation of the results of the analysis of economic activities for making competent management decisions on sustainable environmental management in the context of the principles of a "green" economy, which in turn will weaken demotivation of petrochemical enterprises to the involvement of industrial waste in recycling, will reduce the amount of accumulated hazardous waste in open areas and reduce the risks of developing a hidden market.

References

1. Bina, O., La Camera, F. (2011). Promise and shortcomings of a green turn in recent policy responses to the "double crisis". *Ecological Economics*, 70, (12), 2308–2316. <https://doi.org/10.1016/j.ecolecon.2011.06.021>
2. *Test of the OECD set of green growth indicators in Germany* (2013). German Federal Statistical Office. Wiesbaden. 2012. Available at: https://www.destatis.de/EN/Publications/Specialized/EnvironmentalEconomicAccounting/Sustainability/TestOECDGreenGrowth5850016129004.pdf?__blob=publicationFile
3. Hertwich, E.G., Peters, G.P. (2009). Carbon footprint of nations: a global, trade-linked analysis. *Environmental Science & Technology*, 43, 6414–6420. <https://doi.org/10.1021/es803496a>
4. Wiedmann, T., Schandl, H., Lenzen, M., Moran, D., Suh, S., West, J., Kanemotoc, K. The Material Footprint of Nations. (2012). In *Proceedings of the National Academy of Sciences of the United States of America*, 112 (20), 6271–6276. <https://doi.org/10.1073/pnas.1220362110>
5. *Towards a green economy: pathways to sustainable development and poverty eradication*. (2011). United Nations Environment Programme. Available at: <https://sustainabledevelopment.un.org/index.php?page=view&type=400&nr=126&menu=35>

Organizational Competence in Managing Transformation

Jolanta Žemguliene

Vilnius University, Lithuania

E-mail: jolanta.zemguliene@evaf.vu.lt

Mantas Valukonis

Vilnius University, Lithuania

E-mail: mantas.valukonis@evaf.vu.lt

Keywords: organizational transformation, organizational competence, organizational competence to transform.

JEL code: L22.

Introduction

Research of organizational transformation has provided comprehensive knowledge how transformation process works. Knowledge of the organizational transformation process, causes, mechanisms have been developed in at least three organizational transformation paradigms - evolutionary, punctuated equilibrium, institutionalism (Besson, Rowe, 2012). Recent studies have addressed to specific modes of transformation - digital transformation (Verhoef et al., 2021), organizational culture transformation (Trushkina et al., 2020), transformation towards smart factory system (Jerman, Bach, Aleksic, 2020), IT-enabled transformation (Wessel et al., 2021). Still concern about the transformational competence lays in the logic of mind as the question who and what enable organization to reach successful result of transformation. Understanding the alignment of transformational process in the frame of the competency approach suggests that individuals and groups of persons should possess specific knowledge how to rule organization through the process of change. This paper contributes to existing discourse on organizational transformation by taking a focus on particular type of organizational competences that enables organizational transformation. By integrating research in the areas of organizational transformation and organizational competence, we analyze what are the competences that contribute to the development of organization's capability to transform. Theorizing about transformational competence of organization is based on a common approach of decomposing competence into its elements.

In this study analysis of the scientific literature was utilized to explore the concept of transformational competence and to provide the framework of transformational competence of organization. Based on synthesis of findings from the literature, dimensions of transformational competence were identified: competence of sensing opportunities in the organization's environment, competence of acquiring and exploiting knowledge, competence associated with the capability to generate viable transformational strategy, competence of change management, competence associated with the capability to coordinate activities, competence of integrating individual knowledge to the group and creating collective

sense making. Extending the studies of organizational transformation this paper proposes a conceptual underpinning that provide meaning structures to be usefully employed in constructing models for its empirical validation and application at the organizational level.

1. Organization's capabilities as antecedents of competence

In this study, seeking for theoretical justification and reasonable interpretation of transformational competence, firstly the enquiry on interpretation of organizational competence was made. Strategic management theory focuses on competitive advantage and emphasize core competence of the organization as supporting this advantage. Since Prahalad, Hamel (1990) proposed notion of core competence, idea of core competence as organization's collective knowledge was also developed for the entire organization by defining the organization as a portfolio of key competences. Teece, Pisano, Shuen defined the core competences as "those competences that define a firm's fundamental business" (Teece et al., 1997, p.516). Also Dosi, Teece (1998, p.284) provided more descriptive definition of distinctive competence referring this specific competence as a set of skills, assets and routines possessed to coordinate activities in pursuit of competitive advantage. Resource based view explores organizational competence as resources possessed by organization that help to gain and utilize firm-specific competitive advantage (Santos, Eisenhardt, 2005). Some authors interpret competence as firm's ability to produce output significant in terms of competitive advantage (Eisenhardt, Martin, 2000). Relying on the insights of resource based theory, organizational competencies are portfolios of resources or assets configured to competitive advantage in market domains. As Kogut, Kulatilaka (2001) defined, a core competence is a sub-set of the capabilities of a firm. Although some authors refer to capabilities as operational or functional lower-order competencies, the concepts of capabilities and competencies are not identical (Protogerou, Caloghirou, Lioukas, 2012). As organization's capabilities refer to its potential to achieve organization's goals, and organizational competence refer to knowledge based assets integrated into products or configured to processes or routines, capabilities are exploited to create competences. Change initiatives are concerned with the reconfiguration of organization's deep structure or organization's processes, which subsequently impact on organization's core competence and performance.

2. Definition of organizational competence to transform

Alignment of transformational process in the frame of strategic management approach suggests that managers should possess specific knowledge how to rule organization through the process of change. Understanding organizational transformation phenomena from the perspective of resource based view is grounded in organization's distinctive capabilities that are built or acquired in order to transform organization's strategies, systems, governance or values. Basic assumption is about competence of the individuals (executives, managers) and groups within the organization to execute transformation. As the capability of individuals and groups to perform transformation – related routines, processes and activities are exploited, the outputs of the structural transformation, strategy transformation, organization's culture transformation appear. In responding to external and internal pressures for change,

firms adopt a variety of dynamic capabilities as specific routines, including re-engineering, outsourcing, restructuring, corporate venturing, product development, alliancing, strategic decision making (Baden-Fuller, Volberda, 1997; Eisenhardt, Martin, 2000), by which organization modifies its operational capabilities (Zollo, Winter, 2002).

Based on the definition of organizational competence, organizational transformation competence is a set functional competences related to organization's capability to transform its structures, systems, strategy and values. Competences specify the sufficiency of capabilities needed to execute a specific activity in order to achieve alignment of organization's modes of existence within the internal and external environment. In order to explore substantive nature of organization's competence to transform it is useful to abstract broader composite dimensions from the specific activities that are identified as transformation outcome generating activities.

3. Dimensions of organizational competence to transform

Organizational transformational competence refers to capability of organization's agents, groups and assets to provide transformation activities in creating strategies, structures systems, culture, designed to achieve transformational outcomes. Content analysis of literature was performed to link the activities with the transformation results. Based on findings from literature a list of activities was compiled and transformation related outcomes were abstracted. Based on the synthesis of findings from literature, it is possible to identify dimensions of transformational competence: competence of sensing opportunities in the organization's environment, competence of acquiring and exploiting knowledge, competence associated with the capability to generate viable transformational strategy, competence of change management, competence associated with the capability to coordinate activities, competence of integrating individual knowledge to the group and creating collective sense making. Transformational competence of organization is a firm specific unique outcome of transformation related routines and processes. Yet, while transformation competence is path-dependent of individual firm, it exhibits common functional competences.

Conclusions

Proposed concept of organization's transformational competence consider theoretical perspective in line with organizational competence theory. Contributing to the literature on organizational transformation, this research develops the concept of transformational competence of organization and identifies functional competences needed for organization to transform. These insights provide a theoretical framework for empirically exploring transformational competence of organization. Future studies are needed to address empirical validation of the concept.

References

1. Baden-Fuller, Ch., Volberda, H.W. (1997). Strategic renewal: how large complex organizations prepare for the future. *International Studies of Management and Organization*, 27(2), 95–120.
2. Besson, P., Rowe, F. (2012). Strategizing information systems-enabled organizational transformation: A transdisciplinary review and new directions. *Journal of Strategic Information Systems*, 21, 103–124.
3. Dosi, G., Teece, D.J. (1998). Organizational competencies and the boundaries of the firm. In: Arena R., Longhi C. (Ed.), *Markets and Organization*, 284. Berlin, Heidelberg, Springer.
4. Eisenhardt, K.M., Martin, J.A. (2000). Dynamic capabilities: what are they? *Strategic Management Journal*, 21, 1105–1121.
5. Jerman, A., Bach, M.P, Aleksic, A. (2020). Transformation towards smart factory system: Examining new job profiles and competencies. *Systems Research and Behavioral Science*, 37, 388–402.
6. Kogut, B., Kulatilaka, N. (2001). Capabilities as real options. *Organization Science*, 12(6), 744–58.
7. Prahalad, C. K., Hamel, G. (1990). The core competence of the corporation. *Harvard Business Review*, May–June, 1–14.
8. Protogerou, A., Caloghirou, Y., Lioukas, S. (2012). Dynamic capabilities and their indirect impact on firm performance. *Industrial and Corporate Change*, 21(3), 615–647.
9. Santos, F.M., Eisenhardt, K.M. (2005). Organizational Boundaries and Theories of Organization. *Organization Science*, 16(5), 491–508.
10. Teece, D.J., Pisano, G., Shuen A. (1997). Dynamic capabilities and strategic management. *Strategic Management Journal*, 18(7), 509–33.
11. Trushkina, N., Abazov, R., Rynkevych, N., Bakhautdinova, G. (2020). Digital transformation of organizational culture under conditions of the information economy. *Virtual Economics*, 3(1).
12. Verhoef, P.C., Broekhuizen, T., Bartb, Y., Bhattacharyaa, A., Qi Donga, J., Fabiana, N., Haenleinc, M. (2021). Digital transformation: A multidisciplinary reflection and research agenda. *Journal of Business Research*, 122, 889–901.
13. Wessel, L., Baiyere, A., Ologeanu-Taddei, R., Cha, J., Blegind-Jensen, T. (2021). Unpacking the difference between digital transformation and IT-enabled organizational transformation. *Journal of the Association for Information Systems*, 22(1).
14. Zollo, M., Winter, S.G. 2002. Deliberate Learning and the Evolution of Dynamic Capabilities. *Organization Science*, 13(3), 339–351.

Identification and Assessing Risks of Material Misstatement of the Financial Statements

Deimantė Žukauskaitė

Mykolas Romeris University, Lithuania
E-mail: dezukauskaite@stud.mruni.eu

Dalia Daujotaitė

Mykolas Romeris University, Lithuania
E-mail: daujotaite@mruni.eu

Keywords: audit, risk assessment, risk of material misstatement

JEL code: M42 – Auditing

Introduction

Assessing the risk of material misstatement in the audit plays an important role, which has a decisive influence on the quality of the audit.

The purpose of the article is to identify factors, which affect risk assessment of material misstatement during the financial statement audit and to define the extended composition of risk of material misstatement. The object of the research is risks of material misstatement and their components. Tasks formulated to achieve the goal: 1) to determine risk factors that may affect specific assertions or be pervasive to the financial statements as a whole and dependencies between the risk of material misstatement components. 2) to identify aspects of improving most common audit risk models. Research methods used in the article include the content analysis of scientific literature, induction and deduction methods.

1. Factors affecting risk of material misstatement

The key premise of a risk-based audit is that auditors should assign more resources to financial statements line items that are more likely to be misstated and less to those that are less likely to be misstated (Kozloski, et al., 2011; Coetzee, et al., 2014). Therefore, an incorrect risk assessment may result in the audit evidence obtained being insufficient to express an appropriate auditor's opinion on client's financial statements.

The risk of material misstatement is caused by entities' activities risk (inherent risk) and control risk. Inherent risk is subject to diversity and complexity because it is affected by many factors (Nguyen, et al., 2020). Number of researchers (Mackevičius, et al., 2012; Ruhnke, et al., 2014; Munteanu, 2015; Selisteanu, et al., 2015; Botez, 2015; Nikolovski, et al., 2016; Florea, et al., 2012; Monroe, et al., 1993) analyzed factors influencing the level of inherent risk and usually distinguishes the following conditions that determine the level of inherent risk: (1) the specifics of the client's business and industry; (2) management characteristics; (3) the size of account balances, the number and nature of transactions; (4) account balances and disclosures (5) susceptibility of property to misappropriation or loss.

However, the inherent risk is caused by far more factors such as complex and strict political and regulatory environment, economic downturn, unstable legal environment, constantly changing technological environment, incorrect business strategy, the lack of business information, failing in the competitiveness (Nguyen, et al., 2020).

The analysis of inherent risk aspects in the literature (Peter, 2013, 100; Mackevičius, et al., 2018, 74; Munteanu, 2015, 100) often emphasizes the separation of inherent risk factors between those that may affect specific assertions and financial statements as a whole. The importance of inherent risk assessment, not only at the level of financial statements but also at the level of assertions, is unquestionable as it allows to plan a specific response to the risks associated with a particular assertion. Therefore, focusing too little on risk assessment at the level of account balances and transactions assertions may reduce audit efficiency and quality.

To avoid the influence of these factors and to reduce the probability of material misstatements, companies are implementing internal controls, effectiveness of which represent the control risk. This risk is affected by the strength of control environment, efficiency of management's risk assessment processes, information and communication, implemented control activities and monitoring procedures in place (Simonaitytė, 2014; Nguyen, et al., 2020).

Finding out the causes of inherent risks and understanding the controls that are created to respond to these risks help auditors determine risk capability of material misstatements. However, the auditor should also consider the interdependence of inherent and control risks in the risk assessment (Ritchie et al., 2007; Dirsmith, et al., 1991; Messier et al., 2000). Without acknowledging interrelations between those risks, the risk of material misstatement may be assessed incorrectly (Munteanu, 2015; Dusenbury, et al., 2000; Messier, 2000).

2. Aspects of improving audit risk models in terms of the risk of material misstatement

Due to the complex risk assessment process, auditors face difficulties in planning the audit, therefore, the scientific literature suggests different risk assessment models that provide guidance for the audit risk assessment process.

The benefits of most common audit risk models are often emphasized in that they provide a better understanding of audit risk and its components and are useful in audit planning, however, the scientific literature agrees on number of aspects for improvement: do not reflect the interdependence between inherent and control risks; the exact method for calculating the level of audit risk components is not provided; inherent and control risk assessments are subjective; do not cover all risks that may arise during the audit; insufficient to assess the risk of fraud; do not show that audit risk needs to be assessed not only at the level of the financial statements but also at the level of the assertions; do not include the need to review the risk assessment during the audit (Arens, et al., 1997; Dusenbury, et al., 2000; Messier, et al. 2000; Bell, et al., 2005; Nelson, et al., 2005; Jankūkainė, et al., 2005; Staniulienė, et al., 2009; Akresh, 2010; Eimanavičiūtė, et al., 2014; Arzhenovskiy, 2019).

Authors also emphasize that the existing models may not be sufficient for the risk assessment of specific risks: existing models provide guidelines for general risk assessment only, and the risk assessment model should clearly reflect the risk assessment process that may have a material effect on the financial statements and requires specific auditor attention due to a more complex assessment process or a higher level of uncertainty. These risks include

the risk of fraud, the risk related to accounting estimates, and the risk of going concern (see proposed composition in Figure 1):

- it is difficult to identify fraud by using traditional methods (Kanapickienė, et al., 2004, 27), therefore the assessment of fraud must include specific risk assessment procedures directed at it. In the process of assessing fraud, the auditor should consider the conditions under which fraud occurs, including incentive/pressure, motivation, and opportunity (Marchesi, 2013, 201). The benefits of including these factors in fraud risk assessment have also been substantiated by researchers (Fortvingler, et al., 2016; Mock, et al., 2017);
- revised ISA 540 (2018) specifies that the assessment of inherent and control risks related to accounting estimates must be performed separately. Accounting estimates are one of the most important risks in financial statements, which is widespread and can have a material effect on an entity's financial position and performance (Pinello, et al., 2020, 23). However, auditors face difficulties in auditing accounting estimates (Griffith, 2014, 49) and the scientific literature does not suggest methods to assess the risk of material misstatement associated with accounting estimates (only general inherent risk assessment methods are proposed);
- the going concern risk assessment includes specific procedures aimed at identifying events and conditions that may indicate the entity's difficulty in continuing as a going concern and therefore, traditional methods may be also insufficient for going concern risk assessment.

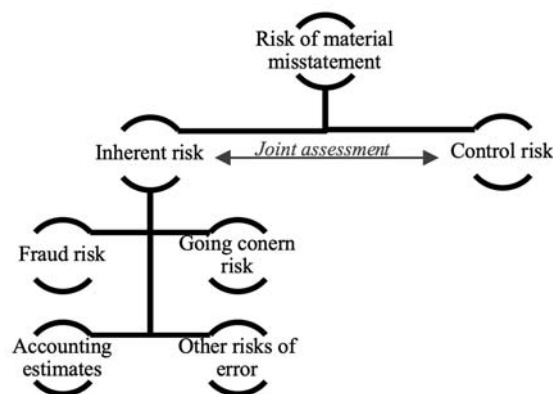

Figure 1. The composition of the risk of material misstatement
Source: compiled by authors

Conclusions

1. The level of risk of material misstatement is determined by a number of factors at the level of specific assertions and the financial statements as a whole. It is important that the auditor consider the relationship between inherent and control risks, because ignoring their interrelation may result in an incorrect risk assessment.
2. Various audit risk models were proposed by researchers, however a number of aspects for improvement still exist. Authors emphasize that the risk of material misstatement model should reflect a separate process in assessing risk of fraud, going concern and accounting estimates related risks, the complexity of which is also emphasized in the auditing standards.

References

1. Arens, A. A., Loebbecke, J. K. (1997). *Auditing: an integrated approach*. Upper Saddle River: Prentice-Hall International.
2. Arzhenovskiy, S. V., Bakhteev, A. V., Sinyavskaya, T. G., Hahonova, N. N. (2019). Audit risk assessment model. *International Journal of Economics and Business Administration*, VII, Special Issue 1, 74–85. doi: 10.35808/ijeba/253
3. Bell, T. B., Peecher, M. E., Solomon I. (2005). *The 21st century public company audit: conceptual elements of KPMG's global audit methodology*. KPMG International.
4. Botez, D. (2015). Study regarding the need to develop an audit risk model. *Audit Financier*, 13(125), 69–74.
5. Coetzee, P., Lubbe, D. (2014). Improving the efficiency and effectiveness of risk-based internal audit engagements. *International Journal of Auditing*, 18(2), 115–125. doi: 10.1111/ijau.12016
6. Dirsmith, W. N., Haskins, M. E. (1991). Inherent risk assessment and audit firm technology: A contrast in world theories. *Accounting, Organizations and Society*, 16(1), 61–90. doi: 10.1016/0361-3682(91)90033-B
7. Dusenbury, R. B., Reimers, J. L., Wheeler, S. W. (2000). The audit risk model: an empirical test for conditional dependencies among assessed component risks. *Auditing: a Journal of Practice & Theory*, 19(2), 105–117. doi: 10.2308/aud.2000.19.2.105.
8. Eimanavičiūtė, L., Kustienė, A. (2014). Audito rizikos vertinimo problematika: teoriniai ir praktiniai aspektai. *Socialiniai mokslai ekonomika*, 1(41), 31–37.
9. Florea, R., Florea, R. (2012). The Implications of inherent risks' assessment in audit risk limitation. *Economy Transdisciplinarity Cognition*, 15(1), 45–49.
10. Fortvingler, J., Szívós, L. (2016). Different approaches to fraud risk assessment and their implications on audit planning. *Periodica Polytechnica Social and Management Sciences*, 24(2), 102–112. doi: 10.3311/PPSo.8436
11. Griffith, E. E., Mannersley, J. S., Kadous, K. (2014). Auditor mindsets and audits of Complex estimates. *Journal of Accounting Research*, 53(1), 49–77. doi: 10.1111/1475-679X.12066
12. International Auditing and Assurance Standards Board (IAASB). (2018). *International Standard on Auditing 540 (Revised): ISA 540 (Revised) and Conforming and Consequential Amendments to Other International Standards Arising from ISA 540 (Revised)*. Available at: https://www.ifac.org/system/files/publications/files/ISA-540-Revised-and-Conforming-Amendments_0.pdf
13. Jankūnaitė, R., Kanapickienė, R., Gipienė, G. (2005). Employment of audit risk models. *Ekonomika*, 71, 59–76. doi: 10.15388/Ekon.2005.17524
14. Kanapickienė, R., Gipienė, G., Jefimovas, B. (2004). Apgaulių ir klaidų rizikos vertinimas audito metu. *Ekonomika*, 67(2), 27–38. doi: 10.15388/Ekon.2004.17379
15. Kozloski, N. K., Messier, W. F. (2011). Strategic analysis and auditor risk judgments. *Auditing: A Journal of Practice & Theory*, 30(4), 149–171. doi: 10.2308/ajpt-10147
16. Mackevičius, J., Strolaitė, A. (2012). Inherent risk and its evaluation. Available at: http://elib.psu.by:8080/bitstream/123456789/20174/1/Mackevi%C4%8Dius%20J_%D1%81134-142.pdf
17. Marchesi, M. F. (2013). Effects of decomposition and categorization on fraud-risk assessments. *Auditing: a Journal of Practice & Theory*, 32(4), 201–219. doi: 10.2308/ajpt-50528
18. Messier, W. F., Austen, L. A. (2000). Inherent risk and control risk assessments: evidence on the effect of pervasive and specific risk factors. *Auditing: A Journal of Practice & Theory*, 19(2), 119–131. doi: 10.2308/aud.2000.19.2.119
19. Mock, T. J., Srivastava, R. P., Wright, A. M. (2017). Fraud risk assessment using the fraud risk model as a decision aid. *Journal of Emerging Technologies in Accounting*, 14(1), 37–56. doi: 10.2308/jeta-51724
20. Monroe, G. S., Juliana, K. L., Woodliff, D. R. (1993). The importance of inherent risk factors: auditors' perceptions. *Australian Accounting Review*, 3(6), 34–46. doi: 10.1111/j.1835-2561.1993.tb00370.x
21. Munteanu, C. C. (2015). Audit risk assessment in the light of current European regulations. *Accounting and Auditing*, 11(3), 94–105.

22. Nelson, M., Tan, H. T. (2005). Judgment and decision-making research in auditing: A task, person, and interpersonal interaction perspective. *Auditing: a Journal of Practice & Theory*, 24, 41–71. doi: 10.2139/ssrn.761706
23. Nikolovski, P., Zdravkoski, I., Menkinoski, G., Dichevska, S. (2016). The concept of audit risk. *International Journal of Sciences: Basic and Applied Research (IJSBAR)*, 27(1), 22–31.
24. Nguyen, H., Kieu Trang Ngo, T., Tam Le, T. (2020). Risk of material misstatement in the stage of audit planning: empirical evidence from Vietnamese Listed Enterprises. *Journal of Asian Finance, Economics and Business*, 7(3). doi:10.13106/jafeb.2020.vol7.no3.137
25. Peter, E. G., Ebimobowei, A. (2013). Audit risk assessment and detection of misstatements in annual reports: empirical evidence from Nigeria. *Research Journal of Finance and Accounting*, 4(1), 97–108.
26. Pinello, A., Puschaver, L., Volkan, A. (2020). The relationship between critical accounting estimates and critical audit matters. *Accounting & Taxation*, 12(1), 23–33.
27. Ritchie, B., Khorwatt, E. (2007). The attitude of Libyan auditors to inherent control risk assessment. *The British Accounting Review*, 39(1), 39–59. doi: 10.1016/j.bar.2006.11.001
28. Ruhnke, K., Schmidt, M. (2014). Misstatements in financial statements: the relationship between inherent and control risk factors and audit adjustments. *Auditing: A Journal of Practice & Theory*, 33(4), 247–269. doi: 10.2308/ajpt-50784
29. Selisteanu, S., Florea, N.M., Buziernescu, R. (2015). Financial audit – risks identified in the audit planning stage. *Annals of University of Craiova – Economic Sciences Series*, 1(43), 133–141.
30. Simonaitytė, Ž. (2014). Kontrolės rizikos vertinimo problemos ir jų sprendimo būdai. In *Accounting, Audit, Analysis: Science, Studies and Business Synthesis*. Vilnius: Vilnius University Publishing House, 327–343.
31. Staniulienė, J. D., Khrystauskas, Ch. (2009). Review of risk models in the context of financial audit. In *Міжнародний збірник наукових праць*, Випуск 3(15), 294–306.



Designer Jurga Tėvelienė
Layout Vida Vaidakavičienė

Vilnius University Press
Saulėtekio Av. 9, LT-10222 Vilnius
info@leidykla.vu.lt, www.leidykla.vu.lt

Books online bookshop.vu.lt
Scholarly journals journals.vu.lt

8,4 autor's sheet