

Diversity and biostratigraphic utility of Ordovician brachiopods in the East Baltic

Linda Hints^a, David A. T. Harper^b and Juozas Paškevičius^c

^a Department of Geology, School of Science, Tallinn University of Technology, Ehitajate tee 5, 19086 Tallinn, Estonia; linda.hints@ttu.ee

^b Palaeoecosystems Group, Department of Earth Sciences, Durham University, Durham DH1 3LE, UK; david.harper@durham.ac.uk

^c Institute of Geosciences, Vilnius University, 3 Universiteto St., 01513 Vilnius, Lithuania; Juozas.Paskevicius@gf.vu.lt

Received 11 January 2018, accepted 14 March 2018, available online 5 June 2018

Abstract. The stratigraphy of the Ordovician carbonates of Baltoscandia was initially based, during the 19th century, on the stratigraphical ranges of macrofossils, mainly trilobites, but other fossils (brachiopods, echinoderms and cephalopods) were also used. During the 20th century, their importance in biostratigraphy gradually decreased due to a greater reliance on microfossils, especially conodonts and chitinozoans, which enable accurate correlation of carbonate successions where graptolites are absent or very rare. New methods have further reduced the attraction of macrofossils for biostratigraphy, although they are useful tools in different fields of geology such as palaeobiogeography and palaeoecology. The revised data on species diversity and the stratigraphical distribution of articulated brachiopods with carbonate shells (rhynchonelliformeans) in the East Baltic are used here for the evaluation of their role and potential in the modern stratigraphy of the Ordovician System. The 106 stratigraphical units (mainly formations and members) belonging to 17 Ordovician and the lowermost Silurian regional stages are analysed based on the taxonomic composition of their brachiopod faunas comprising in total more than 400 species. The cluster analysis used in this stratigraphical experiment captures the major dissimilarities between and continuity of the regional subseries, stages and subregional units by the similarity of their brachiopod faunas. Bryozoans, another important group of benthic organisms in shallow-water facies, are analysed for comparison, providing a test for the correlations based on brachiopods.

Key words: brachiopods, multivariate data analysis, biostratigraphy, diversity, East Baltic.

INTRODUCTION

The Ordovician stratigraphical framework of Baltoscandia, including the East Baltic, was established during the 19th and beginning of the 20th centuries (Schmidt 1858, 1881, 1907; Törnquist 1883; Warburg 1910). In Estonia, the stage-level stratigraphy and names of units were defined by Schmidt. The detailed subdivisions of the Lower and lowermost Middle Ordovician in the Klint area of Estonia and NW Russia are those of Lamansky (1905). The stratigraphic ranges of trilobites and a few other fossil groups were the main tools for the correlation of Ordovician strata.

The stratigraphy of the Ordovician in the East Baltic is based traditionally on a combination of lithological characteristics, which define the formations and members (Männil & Meidla 1994), together with biostratigraphic information, including the zonal ranges of fossils. In the lower half of the Ordovician, trilobites are essential

for correlation; their zonation was recently revised by Bergström et al. (2013). Nowadays the exact correlation of the carbonate rocks of the Baltic sections is based on a biozonation of the distribution of conodonts and chitinozoans (Nõlvak et al. 2007; Männik & Viira 2012). The use of graptolites in biostratigraphy is limited in these rocks (Paškevičius 1973, 2011; Männil 1976).

The current study deals with the East Baltic region and covers the Baltic States of Estonia, Latvia and Lithuania together with the northwestern part of Belarus. This region represents the main areas of the Estonian and Lithuanian shelves separated by the Livonian Basin (Fig. 1). The easternmost territories with Ordovician strata, including the St Petersburg area, are not considered in this study. Incorporating these data would have required more material from the areas east of the Baltic region, including the Moscow Basin, which is beyond the scope of this study. Notable extensive investigations of the brachiopod faunas, environments and stratigraphy

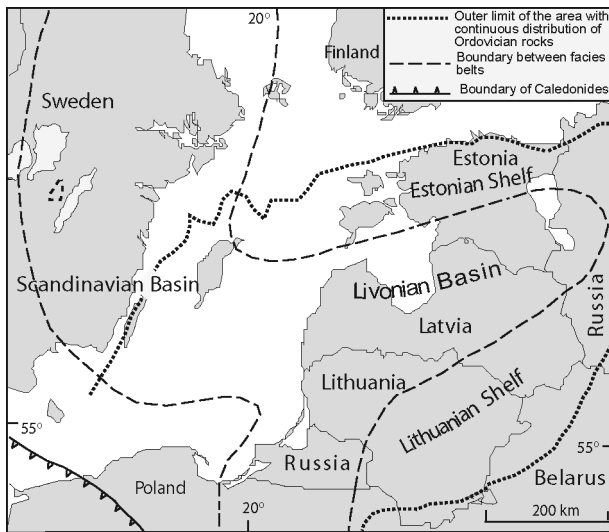

Fig. 1. Major palaeogeographic features of the Baltic Basin (modified from Harris et al. 2004).

of the Floian to lower Darriwilian (Hunneberg to Kunda regional stages) have been carried out in the St Petersburg area (Egerquist 1999; Hansen & Harper 2003; Rasmussen et al. 2007, 2016; Rasmussen & Harper 2008). The bed by bed studies of sections have revealed there a much higher brachiopod diversity than in northern Estonia (Rasmussen et al. 2007). The Lower and lowermost Middle Ordovician have a restricted thickness in northern Estonia (Meidla 1997) and are not as fossiliferous as the sections in the easternmost areas noted above.

The facies differentiation and the diversity of benthic faunas in the Baltic Basin are described in several publications (e.g. Paškevičius 1973, 1997, 2000; Jaanusson 1976; Hints & Põlma 1981; Harper 1986; Ropot & Pushkin 1987; Hints 1990a; Laškovas et al. 1993; Hints & Harper 2003; Kaljo et al. 2011). The changes in the composition of the Ordovician biota (e.g. trilobites, brachiopods and bryozoans) along the onshore–offshore profile have been plotted using a dendrogram (Hints 1990a) and illustrated in separate sections (Hints & Põlma 1981; Harper & Hints 2001) in different parts of the region (Paškevičius 2000; Hints & Harper 2003; Kaljo et al. 2011).

More than 400 brachiopod species (presented in Tables S1–S5, available at <http://doi.org/10.15152/GEO.233> as supplementary online material) occur in Ordovician and lowermost Silurian strata in the East Baltic. In addition, about 100 brachiopods have been reported under open nomenclature (sp., aff., cf., sp. nov.) due to poor preservation or insufficient study. About 400 brachiopod taxa occur in the Estonian Shelf and about 200 in the southern part of the region, in the Lithuanian Shelf (including the northwestern part of Belarus)

(Tables S1–S3). Most of the Lithuanian and Belarus brachiopod taxa are in common with those on the Estonian Shelf. The brachiopods in the deepest-water part of the basin (Livonian Basin) are poorly known (Table S4), excepting the topmost Ordovician Hirnantian brachiopod fauna (Hints & Harper 2015; Harper & Hints 2016). The brachiopod distribution and biodiversity of the Estonian and Belarus areas are compared with those of the bryozoans, which represent another important group of benthic organisms in shallow-water shelf environments.

The modern geological context of the Baltic region has been discussed in numerous publications commencing with Männil (1966), who described the general features of the basin, its evolution and faunas. Subsequent overviews of Ordovician faunas and facies are reported in Ropot & Pushkin (1987), Paškevičius (1997) and Raukas & Teedumäe (1997). The differences in the development of brachiopod faunas on the Estonian and Lithuanian shelves, and in the Livonian Basin are worthy of note. The benthic biotas of the shelves, predominantly in carbonate depositional regimes, apparently lacked environmental stress apart from the intervals of emergence indicated by the gaps in the deposition of different durations (Laškovas 2000; Meidla et al. 2014). Three different ecological faunas developed in the Livonian Basin, which were influenced by immigrations from the westernmost areas. Rare and very low-diversity faunas in the red-coloured facies during the Early, first half of the Middle, and Upper Ordovician developed in specific environments with strong, multi-directional currents (Kiipli et al. 2008). Low-diversity brachiopod faunas also occur in black shales formed in anoxic conditions (Kiipli & Kiipli 2013) at two stratigraphical levels within the Katian. In the Livonian Basin, most of identified brachiopods belong to the Sandbian–lower Katian and Hirnantian siliciclastic deposits. In the former case these deposits formed in oxygen-rich marine environments during an interval of volcanic activity (Bergström et al. 1995). During the Hirnantian the environments and biota were stressed by the development of the Gondwana icecap (Brenchley et al. 1994).

The brachiopods have essential roles in studies of various aspects of palaeobiogeography and palaeoecology. Nevertheless, some rapidly evolving lineages, for example the dalmanelloid and plectambonitoid brachiopods, have been used for local and regional correlation, with limited success, in the Middle (Williams 1976) and Upper Ordovician (Bancroft 1945; Wright 1976) rocks of Avalonia. Brachiopod assemblages have been used to characterize rock units, most notably Cooper's (1956) benchmark study of the Ordovician brachiopods of the mid-Continent and margins of eastern North America; that pioneer study developed the value of an assemblage-

based approach but lacked the scaffold of a precise chronostratigraphy. The present study, however, tests the importance of brachiopods in identifying larger, stratigraphic units with precise time constraints and clarifying if, within a regional context, stages, subseries and series can be recognized on the basis of their brachiopod-dominated benthos.

COMMENTS ON BRACHIOPOD TAXONOMY

1. The genus-level taxonomy of the Ordovician rhynchonelliformean brachiopods follows the volumes of the *Treatise on Invertebrate Paleontology* (e.g. Harper 2000; Williams & Carlson 2000; Williams & Harper 2000 and Cocks & Rong 2007). These studies synonymized several new names for Estonian strophomenoid genera published by Rõõmusoks (2004).
2. Open nomenclature (species names with cf., aff., sp. nov.) is used in some cases. In other cases those brachiopods are briefly described (Öpik 1930, 1932, 1934; Hints 1975; Tinn 1998; Hints & Harper 2015).
3. The initial data on the stratigraphical distribution of species are complemented or have been revised by other authors. Up to now, the most complete lists of brachiopod and bryozoan species from the East Baltic Ordovician are those of Rõõmusoks (1966, 1970), Ropot & Pushkin (1987) and Paškevičius (1997). The genus-level overviews are available in Hints (1990b) and Hints & Rõõmusoks (1997), and some aspects of the brachiopod diversity and dynamics in Hints & Harper (2003).
4. The brachiopod data from Belarus (Table S3) are based on nine drill core sections (figs 4–12 in Ropot & Pushkin 1987). The stage-level data on brachiopod distribution in the southern East Baltic (text-table 5 in Ropot & Pushkin 1987) are not used here, because we have revised data for the Lithuanian part of the region (Table S2).
5. The brachiopods from the Livonian Basin have been insufficiently studied and are identified at different taxonomic levels (Table S3). An exception is the Hirnantian fauna (Hints & Harper 2015).

COMMENTS ON THE STRATIGRAPHICAL CONTEXT AND CONTROL

1. In the Baltic region, the modern stratigraphic classification of the Ordovician System, chrono-, bio- and lithostratigraphical units and correlation with the global chronostratigraphical units have been summarized in several key publications (Männil 1966;

Paškevičius 1973, 1997; Ulst et al. 1982; Ropot & Pushkin 1987; Ebbestad & Högström 2007; Nõlvak et al. 2007; Meidla et al. 2014). The stratigraphical chart in Fig. 2 comprises the main regional stratigraphical units (regional stages) and their correlation with the global stages. The lithostratigraphical units (formations and members) identified in the Lithuanian Shelf (Ropot & Pushkin 1987; Paškevičius 1997) (Fig. 2), are ranked on the chart in stratigraphic order within regional stages without exact correlations with the formations and members in Estonia.

2. Nevertheless there are complications concerning the ranges of species because of different or changing opinions on the identification of sequences (mainly those in the Lasnamägi to Kukruse stages) by different authors (e.g. figs 17 and 26 in Rõõmusoks 1970). According to Rõõmusoks (1970, fig. 26) and Männil (1986), stage C2 (Kukruse) of Öpik (1930, 1934) corresponds to the uppermost Uhaku and lowermost Kukruse stages and Öpik's stage C3 (Idavere) corresponds to the Kukruse Regional Stage (RS).
3. The brachiopod data from the Lasnamägi RS possibly need future revision because, based on the characteristic graptolites (Männil 1976, fig. 2), in the Lasnamägi section (Tallinn) (Rõõmusoks 1970, fig. 11) part of that stage should be included in the Uhaku RS.
4. The lower part of the Haljala RS (C3), comprising the Tatruse Formation (Fm.) and Vasavere Member (Mb.), corresponds to the Idavere RS and the upper part to the Jõhvi RS in Rõõmusoks (1970).
5. Studies of the early Katian reefs (Vasalemma Fm.) in northern Estonia (Kröger et al. 2014) have suggested a Keila age for the reef complex, which earlier was partly included in the Oandu RS (Männil 1960; Rõõmusoks 1970). The Saku Mb. of the uppermost Vasalemma Fm. is considered as transitional between the reefs and the carbonate deposits of the Hirmuse Fm. (Männil 1990). According to new data (Kröger et al. 2014, 2017), the Saku Mb. overlies the reefs and its topmost part could be younger than the Hirmuse Fm. Therefore, the ranges of several brachiopods may require adjustment. Some common species (e.g. *Bassettella alata* Hints, *Neoplatystrophia lutkevichi* (Alichova), *Vellamo oanduensis* Öpik, *Ilmarinia dimorpha* Öpik) from the Hirmuse Fm. of the Oandu RS and the Vasalemma Fm. presumably appear first during the Keila in reef environments and may thus no longer indicate an Oandu age.
6. The continuous transition from the Ordovician to Silurian is missing in the East Baltic due to gaps of different durations (Paškevičius 1973, 1997; Nestor & Einasto 1997; Abushik et al. 2007; Männik 2014). The most diverse, early Rhuddanian brachiopod fauna

Global units	Time slices	Regional units			Regional stratigraphical units: formation and member (Mb.), number of unit																	
		Series	Subser.	Stage & Index	ESTONIAN SHELF		LIVONIAN BASIN		LITHUANIAN SHELF													
									Lithuania		Belarus											
S	Rh			Juuru (G1-2)	Varbola	41	Õhne	61	Puikule	91	X											
Upper Ordovician	HIRNANTIAN	6c	ATLA	PORKUNI (F2)	X		Saldus	60	Piltene	90			X									
					Ärina	Kamariku Mb.					40	Kuldiga			59	Vaineikiai	89					
						Tõrevere Mb.					39											
						Siuge Mb.					38											
						Vohilaid Mb.					37											
	Rõa Mb.	36																				
	KATIAN	5d	KOHILA	PIRGU (F1c)	Adila	35	Jelgava	58	Taučionys	88	Taučionys Druva	106										
					Halliku	34			Ukmergė	87			105									
					Moe	33			Svedasai	86				104								
					VORMSI (F1b)	Tudulinna			32	Fjäckä					56	Dobilynė	85	Noroch	103			
	Kõrgessaare	31																				
	KATIAN	5c	VINNI	RAKVERE (E)	Tudu Mb.	28	Priekule Mb.	53	Jakšiai	82	Strusto	102										
					Piitse Mb.	27																
	KATIAN	5b	KURNA	OANDU (D3)	Tõremägi Mb.	26	Mossen	Plunge Mb.	52	Šakiai	81	Smorgon	101									
					Hirmuse	25																
					Saku Mb.	24				Blidene	51			Vilučiai	79							
					Vasalemma (reefs)	23																
					Saue Mb.	22				Adze	50			Šventupys	77	Vangishki	100					
					Pääsküla Mb.	21																
					Kurtna Mb.	20																
Jõhvi Mb.					19																	
KATIAN					5a	PURTSE				HALJALA (C3-D1)	Vasaveere			18	Dreimani	49	Kriaunos	75	Kriaunos	98		
											Tatruse			17								
MIDDLE ORDOVICIAN	4c	ONTIKA	KUKRUSE (C2)	Upper Viivikonna	16	Taurupe	48	Karštai	74	Karštai	97											
				Lower Viivikonna	15																	
				UHAKU (C1c)	Kõrgekallas							14	Stirnas	47	Vyžūnai	72	Miory	96				
				LASN. (C1b)	Upper Vao							13										
				ASERI (C1a)	Lower Vao							12										
MIDDLE ORDOVICIAN	4b	ONTIKA	KUNDA (B3)	Kandle	11	Segerstad	46	Vaidlenai	71	Baldone	45	Juodupė	70	Tverečius	95							
				Upper Loobu	10																	
LOWER ORDOVICIAN	3a	ONTIKA	VOLKHOV (B2)	Lower Loobu	9	Kriukai	43	Gindviliai	67	Spalviškiai	66	Myadel	93									
				Lower Kunda	8																	
				Upper Toila	7									Armonys	64	Leetse	63	Leetse	92			
				Middle Toila	6																	
				Md. Toila (Saka Mb.)	5																	
				Lw. Toila (Päite Mb.)	4									Zebre	42	Salantai Mb.	62	X				
				Up. Leetse (Mäeküla Mb.)	3																	
				Lw. Leetse (Joa Mb.)	2									IRU	VARANGU	Varangu	1	X				
				BILLIN. (B1b)	Lw. Leetse											1						

Fig. 2. Ordovician stratigraphic chart, correlation with global units and time slices, and the successions of main lithostratigraphical units of the Estonian and Lithuanian shelves and Livonian Basin (modified from Ropot & Pushkin 1987; Männil & Meidla 1994; Paškevičius 1997, 2016; Nõlvak et al. 2007; Rubel 2011; Meidla et al. 2014). The numbers of the formations and members (Mb.) are used in Figs 4–8 and in Tables S1–S5 with the stratigraphical distribution of brachiopods. The interval of every second regional stage is marked by grey colour. The formations and members from the Livonian Basin and Lithuanian Shelf are shown in their stratigraphic succession without exact correlation with the units in the Estonian Shelf. Abbreviations: S, Silurian; TREM., Tremadocian; Rh, Rhuddanian; Lw., Lower; Md., Middle; Up., Upper; HUNNEB., Hunnebergian; BILLIN., Billingen; LASN., Lasnamägi; Vasal., Vasalemma Formation. The main gaps are marked by a cross.

noted in this study has been reported from the Estonian shelf (Varbola Fm.) and basal deposits (Õhne Fm.) of the Juuru RS in the Central East Baltic (Rubel & Rõõmusoks 1970; Rubel et al. 1984;

Rubel 2011). In Belarus, the gap is much more extensive than in other parts of the East Baltic and the oldest Silurian is of Telychian age (Abushik et al. 2007).

MATERIAL AND METHODS

The Ordovician brachiopods of the East Baltic have been described in a number of substantial monographic studies (Öpik 1930, 1932; Alikhova 1951, 1953; Alikhova et al. 1954; Rõõmusoks 1959, 2004; Rubel 1961, 2011; Hints 1975; Cocks & Rong 2000; Rubel & Wright 2000) and in numerous shorter papers (Öpik 1932, 1933a, 1933b; Oraspõld 1956, 1959; Rubel 1963; Rõõmusoks 1964, 1981, 1985; Hints 1973, 1979, 1986, 1993, 2012, 2014; Paškevičius 1973, 2016; Rubel & Popov 1994; Tinn 1998; Zuykov 1999; Paškevičius & Hints 2016). These data are supplemented with those from several stratigraphical reviews (Jaanusson 1956; Männil 1966; Rõõmusoks 1966, 1970). The Ordovician and lowermost Silurian brachiopods on the Estonian Shelf are assigned to about 400 species in addition to numerous taxa under open nomenclature. On the Lithuanian Shelf the number of brachiopod species is about a half of that on the Estonian Shelf (Alikhova et al. 1954; Paškevičius 1997). Most of them are also present on the latter shelf. More than 150 taxa of brachiopods occur in the periphery of the Livonian Shelf in northwestern Belarus (Ropot & Pushkin 1987). Some of these species are unknown or have somewhat different stratigraphic distributions in the rest of the East Baltic.

About 100 rhynchonelliformean brachiopods are present in the Livonian Basin. However, many of them are identified only to genus or higher taxonomic levels.

The source data on bryozoans (275 species; see Table S6 at <http://doi.org/10.15152/GEO.233>) used in this paper are based on the faunal lists in Rõõmusoks (1966, 1970) where original data by Ralf Männil (Männil 1958) have been taken into account. The bryozoans in that list possibly need taxonomic revision, however, the species-level analyses seem to be suitably trustworthy. According to Pushkin (in Ropot & Pushkin 1987), 157 species of bryozoans are found on the Lithuanian Shelf (Table S7). In contrast to brachiopods, which have many species in common on the shelves, two thirds of bryozoan species are unknown from the northern East Baltic. This may be artificial, considering difficulties in exact correlation between the two regions and the contrasting number of taxonomic studies in Estonia and Belarus. The binary dataset (based on presence or absence) from 106 stratigraphical units (Fig. 2) captures the brachiopod or bryozoan taxa in each unit; these data are analysed using multivariate analysis (Hammer & Harper 2006). The term ‘unit’ is used in this study for the formations and members which represent deposits and faunas formed in more or less similar and persistent environments. The cluster analysis is based on the distribution of more than 400 brachiopod species together with those identified under the open nomenclature in the Ordovician

and lowermost Silurian of the East Baltic using the neighbour-joining algorithm and the Raup–Crick and Simpson similarity coefficients (Hammer & Harper 2006). These analyses enable us to visualize the similarity of stratigraphical units according to the presence and absence of brachiopod species or their generic composition and highlight how these fossils support the accepted stratigraphy and its correlation.

The original material of the rhynchonelliformean brachiopods used in this study is housed at the Institute of the Geology (Tallinn Technical University), Geological Museum (Tartu), Natural History Museum (Tallinn), Latvian Museum of Natural Sciences (Riga), Institute of Geosciences (Vilnius University) and Belarussian Research Geological-Prospecting Institute (BELNIGRI, Minsk). The large collections, studied by Alikhova, are housed at the Chernyshev Central Scientific Geological and Prospecting Museum (CNIGR museum) in St Petersburg.

THE MULTIVARIATE ANALYSIS

The multivariate technique of cluster analysis (Hammer & Harper 2006) is widely used in palaeobiogeography for the identification of faunal differences between palaeocontinents, regions and faunas of various ages (Tychsen & Harper 2004; Harper et al. 2013), more specifically, in studies of the Ordovician biodiversification (Harper 2006) and faunal turnovers (Zhan et al. 2008). The present use of cluster analysis is somewhat unconventional and differs from those applications, because of its stratigraphically-oriented goals. The neighbour-joining algorithm and the Raup–Crick and Simpson similarity coefficients (see Hammer & Harper 2006) enable visualization of the similarity between different stratigraphical units based on the taxonomic composition of brachiopods. The first coefficient is a probabilistic index based on presence/absence data. The Simpson similarity coefficient characterizes the ratio of the species in common to the number of taxa in the smaller set. The dendrograms based on two coefficients reveal some differences useful in the interpretation of the faunal similarities of separate units.

Cluster analyses of stratigraphical units based on brachiopod composition for the Estonian Shelf

In the East Baltic, the development of brachiopod faunas, their diversity changes and role in the benthic faunas differ essentially between the shelves and the basinal part of the basin (Fig. 3). The brachiopod data from the Estonian Shelf are from 41 stratigraphical units (Fig. 2), arranged into three main clusters using the Raup–Crick

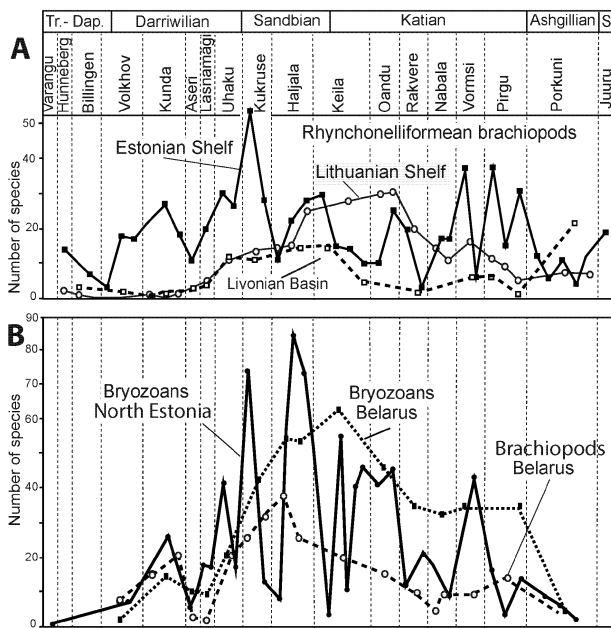

Fig. 3. **A**, the number of rhynchonelliform brachiopod species in the regional stages of the Estonian and Lithuanian shelves and Lithuanian Basin (Tables S1–S3). **B**, the same for brachiopods and bryozoans (Tables S3 and S7) of the Belarus part of the Lithuanian Shelf (Pushkin in Ropot & Pushkin 1987), and bryozoans in northern Estonia (Männil 1958; Rõõmusoks 1966; Table S6). The number of species in one stage is shown by the number of species in the formation or member of that stage (see the respective tables). Abbreviations: Tr.-Dap., Tremadoc–Dapingian; S, Silurian.

and Simpson similarity coefficients (Fig. 4). One cluster comprises the units from the Hunnebergian RS (B1a, units 2, 3) to the Kunda RS (B3) (units 3–10). The Aseri RS (unit 11) belongs, unusually, to that cluster. On the stratigraphical chart (Meidla et al. 2014), and in the cluster based on the Simpson similarity coefficient, it is tied to the overlying units. The units from the Lasnamägi RS (C1b) to Keila RS (D2) (units 12–22) form the second cluster which together with the first one are separated from all other Ordovician units in the interval from the Oandu RS (D3) to Porkuni RS (F2). The major Ordovician faunal change in the shelf facies at the Keila–Oandu transition is a well-known biotic crisis (Meidla et al. 1999) following the Guttenberg carbon isotopic event (GICE, Ainsaar et al. 2010). Both dendrograms (Fig. 4A, A1) very clearly reflect the crisis, but with some exceptions. The Vasalemma Fm. (unit 23) of the Keila RS belongs on both dendrograms to the cluster together with the Oandu–Rakvere (D3–E) units, probably due to the earlier appearance of some brachiopods considered to indicate the Oandu Stage (Fig. 4) (see p. 178). The Rõa Mb. (unit 36), which has been

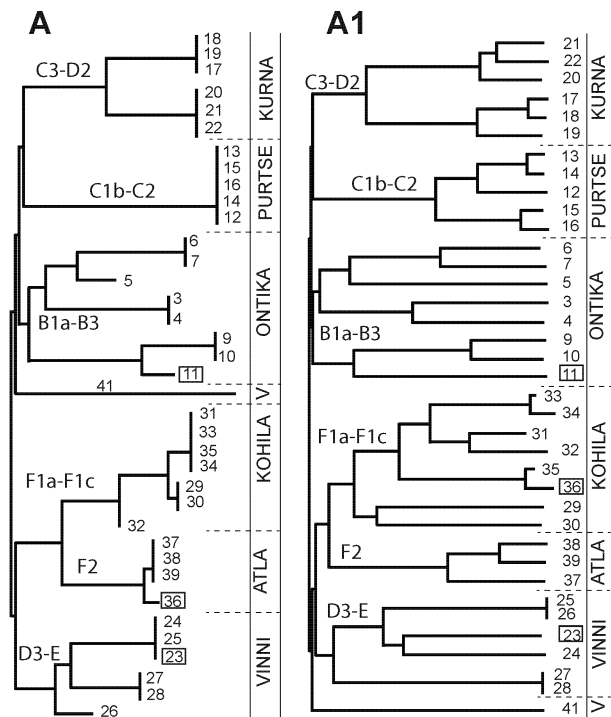

Fig. 4. Cluster analysis of the Ordovician and lowermost Silurian stratigraphical units of the Estonian Shelf. The dendrogram is compiled based on the Raup–Crick (**A**) and Simpson (**A1**) similarity coefficients and a neighbour-joining algorithm (Hammer & Harper 2006) using brachiopod data from the Estonian Shelf (Table S1). The units in rectangles have a questionable position in the cluster. For indices of the regional stages and numbers of the units see Fig. 3. The regional subseries are given to the right of the dendrogram.

included in the Pirgu (Rõõmusoks 1991) or Porkuni RS (Hints et al. 2000), is indicated on the dendrograms with a twofold affiliation. Using the Raup–Crick similarity coefficient, it is associated with the Porkuni RS and using the Simpson coefficient, with the Pirgu RS.

Both dendrograms generated using the Raup–Crick and Simpson similarity coefficients (Fig. 4A, A1) indicate very clearly that during the Ordovician, the Estonian Shelf was inhabited by three different sequential faunas and the main faunal change occurred at the Keila–Oandu transition. In a cluster analysis of the global ranges of orthide and strophomenide taxa (Harper et al. 2009), the main partition occurred during the mid-Darriwilian, probably corresponding to the split in clusters between the Ontika and Purtse subseries. In the East Baltic, this level (boundary between the Lower and Middle Ordovician by earlier interpretations; see Männil 1966) marks also a notable faunal renovation, however, it has not received enough attention in comparison with that at the Keila–Oandu boundary.

Cluster analyses of stratigraphical units based on brachiopod composition for the Lithuanian Shelf

The dendrogram, based on the brachiopod fauna from the Lithuanian Shelf (Fig. 5), differs from that of the Estonian Shelf due to contrasts in Ordovician brachiopod dynamics (see Fig. 3). The dendrogram generated using the Raup–Crick similarity coefficient (Fig. 5A) comprises three main clusters as in the previous case (Fig. 4). Several units (62–71) in the lowermost Ordovician are difficult to assign to clusters due to insufficient brachiopod data from these units. Only units characterized by the brachiopods of the Kunda RS (B3) (units 65–67) form a separate part of the cluster (Fig. 5).

Units 72–77 (Lasnamägi RS to the upper Haljala RS) form a cluster with variable similarities between units. They have low similarities with the overlying units, captured in another cluster comprising the units from the Keila RS to Rakvere RS. The close similarity of the brachiopod faunas of the Auleliai (78) and Vilučiai Fms (79) supports the Keila age of the former unit (Paškevičius 2016). Earlier it was included within the Haljala RS (Paškevičius 1997). The largest cluster, which comprises

units from the Nabala RS (F1a) to Porkuni RS (F2) (units 83–90), is similar to the cluster of units on the Estonia Shelf. The dendrogram generated by the Simpson similarity coefficient (Fig. 5A1) comprises only two main clusters. Both dendrograms (Fig. 5) show that, in contrast with the Estonian Shelf, units of the Keila and Oandu RSs belong to one and the same cluster. The continuity in brachiopod distribution corresponds presumably to the stratigraphically more complete sections in Lithuania than in Estonia (Hints et al. 2016). In Lithuania, the boundary between the Rakvere (E) and Nabala (F1a) RSs appears more marked. The units of these stages belong to different clusters, whereas based on the Raup–Crick coefficient (Fig. 5A), the Keila–Rakvere units are closer to the uppermost strata, but based on the Simpson coefficient (Fig. 5A1), have closer relationship with older strata. The boundary between the Rakvere and Nabala RSs is biostratigraphically easy to recognize by the presence of the chitinozoan zonal species *Armoricochitina reticulifera* (Grahn) in the lowermost Mõntu or Paekna Fms (Männil & Meidla 1994; Nõlvak et al. 2007) of the Nabala RS.

On the periphery of the Lithuanian Shelf, in the north-western part of Belarus (units 92–107), the key changes in the brachiopod faunal composition at the Keila–Oandu transition are more similar to those in the Estonian Shelf than the rest of the Lithuanian Shelf (Fig. 6). This is

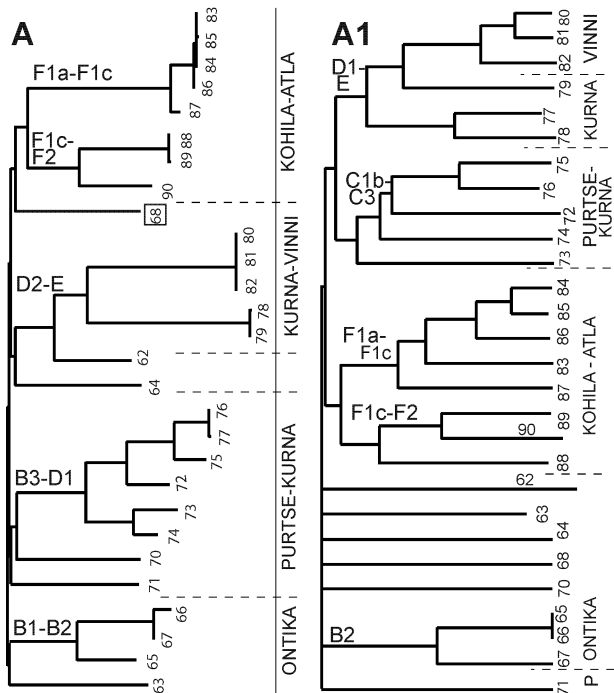

Fig. 5. Cluster analysis of the Ordovician stratigraphical units of the Lithuanian Shelf (in Lithuania). The dendrogram is compiled based on the Raup–Crick (A) and Simpson (A1) similarity coefficients and a neighbour-joining algorithm (Hammer & Harper 2006) using brachiopod data from Lithuania (Table S2). For indices of the regional stages and numbers of the units see Fig. 2. The regional subseries are given to the right of the dendrogram. P, Puikule Fm., Silurian.

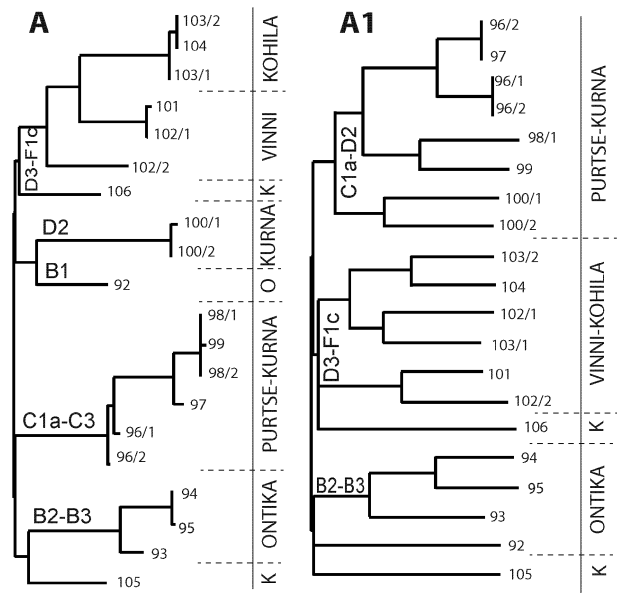

Fig. 6. Cluster analysis of the Ordovician stratigraphical units using the data on brachiopods from Belarus (Ropot & Pushkin, 1987) (Table S3). The dendrogram is compiled based on the Raup–Crick (A) and Simpson (A1) similarity coefficients and a neighbour-joining algorithm (Hammer & Harper 2006). For indices of the regional stages and numbers of the units see Fig. 2. The regional subseries are given to the right of the dendrogram. K, Kohila Subseries; O, Ontika Subseries.

clear on both dendrograms generated based on the Raup–Crick and Simpson similarity coefficients (Fig. 6A, A1). The units (101–104) of the Oandu (D3) to Pirgu (F1c) RSs belong to the same large cluster highlighting the main faunal changes at the Keila–Oandu transition. The Livonian Shelf in Lithuania includes at some stratigraphical levels (Oandu–Rakvere) brachiopods, which occur also in the offshore part of the Estonian Shelf (Hints et al. 2016), again indicating somewhat deeper-water environments in Lithuania than in Estonia. The changes in shelf bathymetry are illustrated by the brachiopod communities in Lithuania (Paškevičius 2000), belonging to benthic associations BA1–2 during the Early and Middle Ordovician, to BA4 in the Oandu and down to BA5 in the late Katian.

Cluster analyses of stratigraphical units based on brachiopod composition for the Livonian Basin

The dendrograms displaying the faunal similarity between the lithostratigraphical units of the Livonian Basin are preliminary due to insufficient brachiopod data (Fig. 7). Like in northern Estonia, the Aseri RS (unit 46) belongs to the cluster together with units of older strata (clusters with units 42–46). The Pirgu RS (units 57, 58) and Porkuni RS (units 59, 60) are indicated on the dendrogram compiled by the Raup–Crick similarity

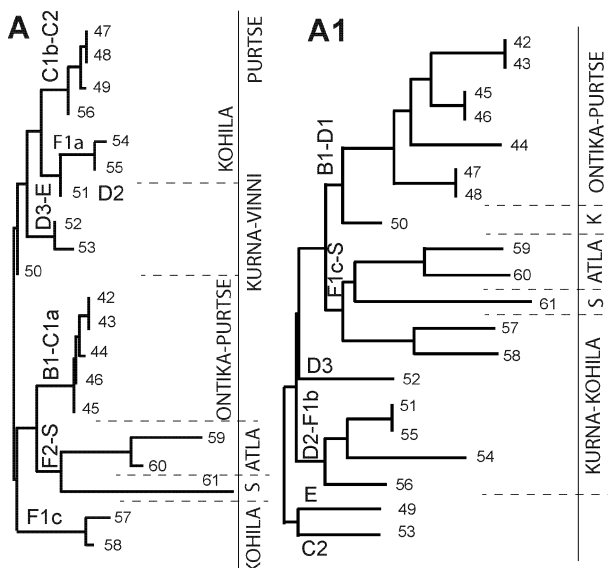

Fig. 7. Cluster analysis of the Ordovician stratigraphical units using the data on brachiopods from the Livonian Basin (Table S4). The dendrogram is compiled based on the Raup–Crick (A) and Simpson (A1) similarity coefficients and a neighbour-joining algorithm (Hammer & Harper 2006). For indices of the regional stages and numbers of the units see Fig. 2. The regional subseries are given to the right of the dendrogram. K, Kurna Subseries; S, Silurian.

coefficient as a separate cluster together with the lowermost Silurian (unit 61). The interval from the Kukruse RS (C2; unit 49) to Vormsi RS (F1a; unit 56) belongs to one cluster with variable levels of similarity between the units. The dendrogram based on data from the Livonian Basin displays unexpected and probably unreliable results due to insufficient baseline data.

COMPARISON OF THE BRACHIOPOD AND BRYOZOAN FAUNAS

Brachiopods are associated with diverse associations of bryozoans in the shelf facies. In Estonia, 275 Ordovician bryozoan species have been identified (Table S6). Their diversity trend through the Ordovician differs, though, from that of brachiopods (Fig. 3). Moreover, the total number of bryozoan species in several stratigraphical units exceeds that of brachiopods (Fig. 3). Many bryozoan species share several (up to 16) succeeding units (Table S5) increasing in diversity with the appearance of new species. The bryozoan diversity increases from the late Uhaku RS (C1c), being the highest in the Sandbian Haljala RS (C3–D1). In contrast to brachiopods, however, the diversity of bryozoans decreases towards the end of the Ordovician (Fig. 3), which follows the global trend in the evolution of the phylum (Taylor & Ernst 2004; Ernst 2018).

The cluster analysis of the stratigraphical units based on the bryozoan species composition (Fig. 8A) shows

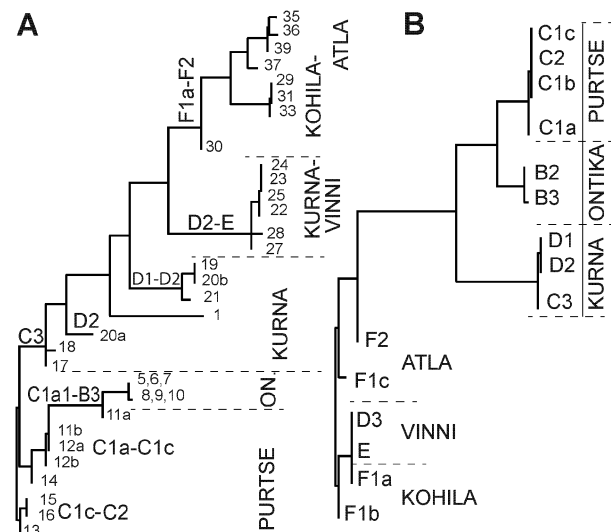

Fig. 8. Cluster analysis of the stratigraphical units based on the composition of the bryozoan species of the Estonian Shelf (A) and Lithuanian shelf in Belarus (B) (Tables S6, S7). In the cluster analysis the Raup–Crick (Hammer & Harper 2006) similarity coefficient and a neighbour-joining algorithm are used. For the numbers of units see Fig. 2. The regional subseries are given to the right of the dendrogram. On, Ontika.

some differences from that based on brachiopods. The dendrogram generated from bryozoan data differs from that based on brachiopods in the step-by-step structure of the dendrogram. Such a structure of the dendrogram is dependent on the large number of bryozoan species sharing many succeeding units (Table S6). The bryozoan data do not show strong faunal differences at the Keila–Oandu transition; a separate cluster comprises the units from the Keila RS to Rakvere RS. The Kukruse bryozoan fauna seems to be rather specific, as the corresponding units [Lower and Upper Viivikonna Fm. (15, 16)] belong to the cluster separated from the others.

The bryozoans from Belarus (Table S7; Fig. 8B), which are analysed at the stage level, are arranged on the dendrogram according to the groups of units corresponding to the regional subseries. They show essential differences between faunas at the Keila–Oandu boundary as revealed by the dendrogram based on the brachiopods from Estonia.

DEVELOPMENT OF THE BRACHIOPOD FAUNA IN THE EAST BALTIC

The brachiopod fauna of Baltica developed during the movement of the palaeocontinent from high to low latitudes, beginning with the early stages of the isolation of the Baltic Province and at the end of the Ordovician with its interface with the Kosov Province (Harper et al. 2013). The dominant brachiopods belong to Orthida and Strophomenida (Harper et al. 2004, 2017; Harper 2006; Curry & Brunton 2007). In the Livonian Basin, the leading factor in modification of the brachiopod faunal succession is the repeated and drastic changes of environments and the immigration of faunas adapted to new environments. This is related, for example, to the immigration of the elements of the deep-water *Foliomena* Fauna and the latest Ordovician *Hirnantia* brachiopod fauna in the Livonian Basin (Hints & Harper 2015; Harper & Hints 2016) together with the faunas of black shales and red-coloured deposits at different stratigraphical levels.

The brachiopod data summarized here, in total more than 400 species from the shelfal and basinal parts of the Baltic Basin (Tables S1–S5), display four intervals characterized by high diversities (Figs 3, 9C). These intervals in the Baltic Basin are correlated with global trends in the development of brachiopod faunas using the time slices of the Ordovician Period (Webby 2004) (Fig. 9B).

In Baltoscandia, the oldest rhynchonelliformean brachiopods (*Apheoorthina daunus* Walcott = *Orthis christianiae* Kjerulf) have been reported from the

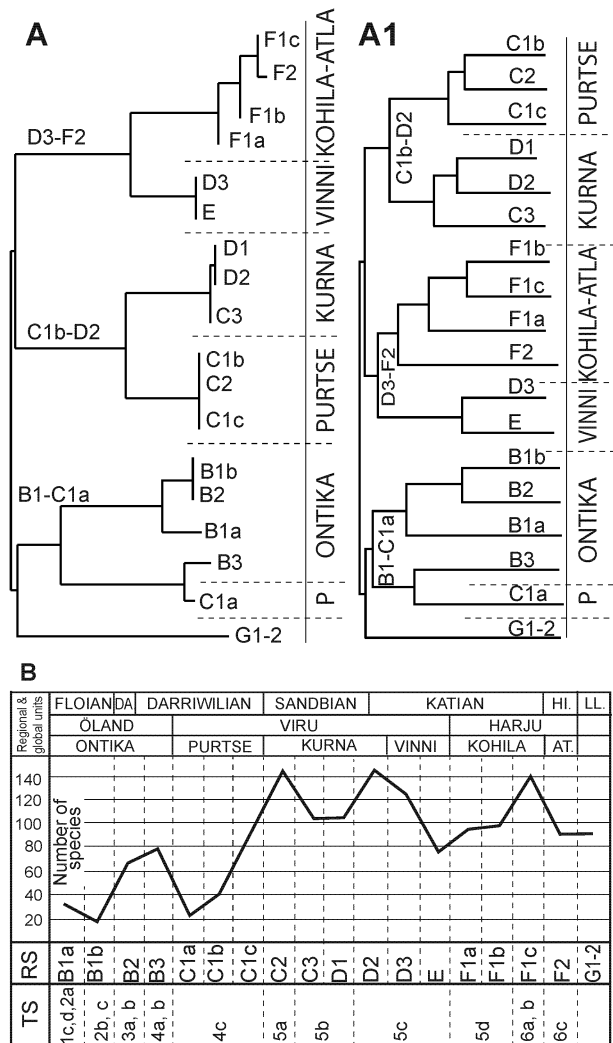

Fig. 9. Cluster analysis of the regional stages of the Ordovician and lowermost Silurian of the East Baltic based on the species composition of the rhynchonelliformean brachiopods (Table S5) based on the Raup–Crick (A) and the Simpson (A1) similarity coefficients using the neighbour-joining algorithm (Hammer & Harper 2006). The regional subseries are given to the right of the dendrogram. B, diversity of the Ordovician rhynchonelliformean brachiopod species in the East Baltic. For indices of the regional stages (RS) see Fig. 2. Abbreviations: TS, time slice (Nölvak et al. 2007); AT, Atla Subseries; DA, Dapingian Stage; HI, Hirnantian Stage; LL, Llandovery.

Tremadocian Ceratopyge Limestone in Sweden (Walcott 1912; Rubel 1961). In the East Baltic, this species together with the oldest representatives of *Plectella*, *Panderina* and *Paurorthis* (unpublished data of Ralf Männil) occurs in the Hunnebergian RS (B1a) of Lithuania, which corresponds to time slices 1c–2a. In the Estonian Shelf, the brachiopod diversity is high in the Volkhov (B2) and Kunda (B3) RSs corresponding to time slices 3 and 4

(Fig. 9B). That was a time of rapid diversification of the dalmanellidines and orthidines (Harper et al. 2004). However, the relatively high diversity in the Kunda RS (time slices 4a, 4b) in the East Baltic, is less than that shown by Rasmussen et al. (2007), whose data are based mainly on more fossiliferous sections in the St Petersburg area, western Russia.

After a diversity fall in the Aseri RS (C1a), a new diversity rise reaches its peak in the early Sandbian Kukruse RS (C2; time slice 5a, Figs 3, 9B). That is a time of rapid global diversification in brachiopod faunas, especially of plectambonitoids and strophomenoids (Harper et al. 2004, 2013; Rasmussen et al. 2007, 2016). In a regional context a marked difference in the brachiopod diversity of the Uhaku (C1c) and Kukruse (C2) RSs, caused by essentially environmental differences, occurs between the Lithuanian and Estonian shelves. In the latter region, unusual environments with kukersite kerogen-rich deposits contributed to the development of a highly diverse biota. That circumstance and the practical importance of kukersite kerogen as a raw material invigorated the studies of brachiopods (Bekker 1921, 1924; Öpik 1928, 1930, 1934). The contemporaneous pack- and wackestones on the Lithuanian Shelf were not especially fossiliferous and the drill core material was inadequate for detailed research.

In the Estonian Shelf, the third brachiopod diversity high occurs on the Sandbian–Katian transition (Keila RS) at the beginning of time slice 5. In contrast with the Estonian Shelf, a diverse brachiopod fauna on the Lithuanian Shelf is found only in the Sandbian and lower Katian (Haljala to Oandu RSs of time slices 5b, 5c; Figs 3A, 9B). The number of species in separate formations of these stages varies within limits close to those in Estonia (Fig. 3A). However, the species diversity drops beginning with the late Katian Vormsi RS towards the end of the Ordovician. The brachiopod dynamics in the Belarus part of the Lithuanian Shelf (Fig. 3B) differs from that in Lithuania (Fig. 3B) in having a diversity peak at the Haljala RS (C3–D1), which follows a decreasing trend in biodiversity.

The fourth brachiopod diversity rise on the Estonian Shelf occurs during the late Katian Vormsi (F1b) and Pirgu (F1c) RSs, which correspond to time slices 6a, 6b (Fig. 9B). Some diversity decrease is observed in the brachiopod associations of the Tudulinna (unit 32, Fig. 2) and Halliku (unit 34, Fig. 2) Fms that were deposited in the somewhat deeper-water environments of the outer part of the Estonian Shelf. The brachiopod diversity drop at the end of the Ordovician is noticeable on shelves (Fig. 3) and continuous transition to the Silurian is interrupted by gaps. The earliest Silurian (unit 41)

brachiopod fauna has 13 genera and one species common with the Ordovician.

In the Livonian Basin, few plectambonitoid brachiopods have been identified among the trilobite-dominated fauna (Männil 1963) of the red-coloured deposits of the Early and most part of the Middle Ordovician (Hunneberg to Aseri RSs). In the Sandbian and early Katian, the brachiopods were represented mainly by small plectambonitoids and orthides, characteristic of the Livonian Basin (Fig. 3). The black shales in two stratigraphical levels of time slices 5c (Keila? RS) and 5d (Vormsi RS) comprise specific associations similar to the *Chonetoidea/Sericoidea*–lingulid association in Norway (Hansen 2008) and in other regions as the deepest association of sowerbyellid–strophomenid–dalmanellid fauna along the onshore–offshore transect (Jaanusson 1984). The red-coloured Katian lithologies of the Pirgu RS (6a, b) comprise brachiopods in common with those of the Jonstorp Fm. in Sweden [*Sowerbyella (Rugosowerbyella) rosettana*] (Jaanusson 1982).

BIOSTRATIGRAPHICAL IMPORTANCE OF BRACHIOPODS IN THE EAST BALTIC

The stratigraphical units from the Estonian Shelf are divided into three main groups (clusters) based on brachiopod composition (Fig. 9). This suggests the occurrence of three evolutionary faunas in the Baltic Basin. One cluster connects the units of the Ontika Subseries (Hunneberg–Kunda RSs, the Lower Ordovician and lower part of the Middle Ordovician). The second cluster comprises the Purtse and Kurna subseries (Lasnamägi–Keila RSs) forming the most part of the Viru Series (Fig. 2). The position of the Aseri RS is somewhat unclear. In some cases it is tied with the older, in some cases with the overlying units. The largest cluster comprises all units from the Oandu RS up to the top of the Ordovician (=Vinni subseries of the uppermost Viru Series, and the Kohila and Atla subseries of the Harju Series). The dendrograms generated from the Estonian and Belarus brachiopod data (Figs 4, 6) indicate that the uppermost units of the Viru Series (Vinni Subseries; Oandu and Rakvere RSs) are aligned biostratigraphically more closely with the units of the Harju Series.

The dendrogram based on the Lithuanian data also delineates three main clusters, but these are slightly different from those generated from the Estonian data. Specifically, the Haljala–Oandu interval is characterized by a high brachiopod diversity on the shelf. The dendrogram based on data from the periphery of the Lithuanian Shelf in Belarus (Fig. 6) corresponds well

to that generated from Estonian data. The units in the interval from the Billingen RS (B1) to the Keila RS (D2) and from the Oandu RS (D3) to the Porkuni RS (F2) belong to different clusters.

The dendrogram compiled using data from the Livonian Basin is preliminary. Insufficient data and stratigraphic problems concerning the correlation of some units (Blidene and Mossen Fms) render a few clusters unreliable. The Aseri RS (C1a) possibly requires additional investigation. In all the dendrograms its corresponding units have more similarity with the older rather than with the younger units. At least part of the Aseri RS shares the *Eoplacognathus pseudoplanus* conodont Zone with the Kunda Stage (Nõlvak et al. 2007).

In spite of the differences in faunal dynamics and the regional stratigraphy of the Ordovician sections in the East Baltic, the dendrograms based on the Raup–Crick and Simpson similarity coefficients contain clusters comprising the units of the subseries (Fig. 9A, A1). An exception is the Aseri RS mentioned above, whose stratigraphic position requires further investigation. The position of the Keila RS in the cluster together with the Oandu and Rakvere RSs (Fig. 5) is presumably driven by the wider stratigraphical distribution of several species in the Keila–Oandu interval in Lithuania or it could indicate problems with regional correlations.

The present study shows that cluster analysis, a robust method for processing multivariate data (Hammer & Harper 2006), gives useful results not only for the global analysis of faunas but also in regional studies of stratigraphy and the vertical distribution of different faunal groups.

The development of the brachiopod fauna of the Baltic Basin indicates that the levels of main changes in its composition do not coincide with the levels of the boundaries of the global chronostratigraphical units of the Early, Middle and Late Ordovician. Nevertheless, the trends in the diversification of the Baltic brachiopods follow the global trends. The oldest brachiopod fauna prior to the Kunda RS (B3) characterizes the interval of replacement of siliciclastic deposits with carbonate lithologies. The upper part (Oandu and Rakvere RSs) of the Viru Regional Series (upper Darriwilian–early Katian) comprises a brachiopod fauna more closely related to succeeding Late Ordovician faunas.

CONCLUSIONS

1. More than 500 taxa of Ordovician rhynchonelliformean brachiopods occur in the 106 environmentally distinct lithostratigraphical units of the East Baltic. Based on the similarity in the composition of

brachiopods, the stratigraphical units are partitioned into three clusters: (1) the units of the Ontika Regional Subseries, (2) the units of the Purtse and Kurna subseries and (3) the units of the Vinni, Kohila and Atla subseries. Dendrograms for different parts of the region show some specific deviations.

2. Short stratigraphical ranges of species delineate the stratigraphical units of different categories up to the stages and subseries levels.
3. Bryozoans appear to have less biostratigraphical value than brachiopods, mainly due to the longer stratigraphical ranges of many species.
4. The faunal crisis at the boundary between the Keila and Oandu RSs is well documented on the dendrograms. The shelfal brachiopod faunas of the upper part of the Viru Regional Series (the Vinni Subseries) are much closer to those of the Harju Series than to the rest part of the Viru Series. This crisis is less pronounced in the basinal facies.
5. The faunal changes on the transition between the Ontika and Purtse regional series needs further investigation.
6. Cluster analysis using two similarity coefficients is a useful tool that captures the similarity of different stratigraphical units based on their faunal composition. This analysis validates the stratigraphical charts and highlights the biostratigraphical role of the rhynchonelliformean brachiopods and global trends in their evolution.

Acknowledgements. We are grateful to Dimitri Kaljo for the critical reading of the manuscript and Olle Hints (both Department of Geology, Tallinn University of Technology) for useful remarks on the compilation of faunal lists and including them in the database available as supplementary material. The reviewers Christian M. Ø. Rasmussen (Natural History Museum of Denmark, University of Copenhagen) and Peep Männik (Department of Geology, Tallinn University of Technology) are thanked for useful comments on the manuscript. This paper is a contribution to IGCP Project 653. The publication costs of this article were partially covered by the Estonian Academy of Sciences.

Supplementary online data

Supplementary online data associated with this article can be found at <http://doi.org/10.15152/GEO.233>. These include the stratigraphical distribution of rhynchonelliformean brachiopods in the Estonian Shelf (Table S1), Lithuanian Shelf (Table S2), Belarus (Table S3), Livonian Basin (Table S4), the stratigraphical distribution of all brachiopods in the East Baltic part of the Baltic Basin (Table S5), and the stratigraphical distribution of the bryozoans in the Estonian Shelf (Table S6) and in Belarus (Table S7).

REFERENCES

- Abushik, A. F., Modzalevskaya, T. L., Moiseeva, T. I. & Pushkin, V. I. 2007. *Silurian and Early Devonian Brachiopods and Ostracods of Byelorussia*. VSEGEI Press, Saint Petersburg, 125 pp. [in Russian].
- Ainsaar, L., Kaljo, D., Martma, T., Meidla, T., Männik, P., Nõlvak, J. & Tinn, O. 2010. Middle and Upper Ordovician carbon isotope chemostratigraphy in Baltoscandia: a correlation standard and clues to environmental history. *Palaeogeography, Palaeoclimatology, Palaeoecology*, **294**, 189–201.
- Alikhova, T. N. 1951. *Brakhiopody srednej i verkhnej chasti nizhnego silura Leningradskoj oblasti i ikh stratigraficheskoe znachenie* [Brachiopods of the Middle and Upper Parts of the Lower Silurian of the Leningrad Region and Their Stratigraphical Significance]. VSEGEI, Gosgeolizdat, Moscow, 81 pp. [in Russian].
- Alikhova, T. N. 1953. *Rukovodyashchaya fauna brakhiopod ordovikskikh otlozhenij severo-zapadnoj chasti Russkoj platformy* [Handbook of the Brachiopod Fauna of Ordovician Deposits of the North-West part of the Russian Platform]. Trudy Vsesoyuznogo Nauchno-Issledovatel'skogo Geologicheskogo Instituta (VSEGEI), Gosudarstvennoe izdatel'stvo geologicheskoy literatury, Moscow, 127 pp. [in Russian].
- Alikhova, T. N., Balashova, E. A. & Balashov, Z. G. 1954. *Polevoj atlas kharakternykh kompleksov fauny otlozhenij ordovika i gotlandiya yuzhnoj chasti Litovskoj SSR* [Field Atlas of Characteristic Faunal Complexes of the Ordovician and Gotlandian of the Southern Lithuanian SSR]. Moscow, 43 pp. [in Russian].
- Bancroft, B. B. 1945. The brachiopod zonal indices of the stages Costonian to Onnian in Britain. *Journal of Paleontology*, **19**, 181–252.
- Bekker, H. 1921. The Kuckers Stage of the Ordovician rocks of NE Estonia. *Acta et Commentationes Universitatis Dorpatensis*, **A**, **II**(1), 1–92.
- Bekker, H. 1924. Mõned uued andmed Kukruse lademe stratigraafia ja faunast [Some new data on the stratigraphy and fauna of the Kukruse Stage]. *Acta et Commentationes Universitatis Dorpatensis*, **A**, **4**(1), 1–20 [in Estonian].
- Bergström, S. M., Huff, W. D., Kolata, D. R. & Bauert, H. 1995. Nomenclature, stratigraphy, chemical fingerprinting, and areal distribution of some Middle Ordovician K-bentonites in Baltoscandia. *Geologiska Föreningens i Stockholm Förhandlingar (GFF)*, **117**, 1–13.
- Bergström, J., Pärnaste, H. & Zhou, Z.-Y. 2013. Trilobites and biofacies in the Early–Middle Ordovician of Baltica and a brief comparison with the Yangtze Plate. *Estonian Journal of Earth Sciences*, **62**, 205–230.
- Brenchley, P. J., Marshall, J. D., Carden, G. A. F., Robertson, D. B. R., Long, D. G. F., Meidla, T., Hints, L. & Anderson, T. F. 1994. Bathymetric and isotopic evidence for a short-lived Late Ordovician glaciation in a greenhouse period. *Geology*, **22**, 295–298.
- Cocks, L. R. M. & Rong, J.-Y. 2000. Strophomenida. In *Treatise on Invertebrate Paleontology Part H: Brachiopoda, Revised. Volume 2: Linguliformea, Craniformea, Rhynchonelliformea (part)* (Kaesler, R. L., ed.), pp. 216–349. The Geological Society of America, Inc. & The University of Kansas, Boulder, Colorado, and Lawrence, Kansas.
- Cocks, L. R. M. & Rong, J.-Y. 2007. Class Strophomenata. In *Treatise on Invertebrate Paleontology Part H: Brachiopoda, Revised. Volume 6 Supplement* (Selden, P. A., ed.), pp. 2598–2638. The Geological Society of America, Inc. & The University of Kansas, Boulder, Colorado, and Lawrence, Kansas.
- Cooper, G. A. 1956. Chazyan and related brachiopods. *Smithsonian Miscellaneous Collections*, **127**, 1–1024.
- Curry, G. B. & Brunton, C. H. 2007. Stratigraphic distribution of brachiopods. In *Treatise on Invertebrate Paleontology Part H: Brachiopoda, Revised. Volume 6 Supplement* (Selden, P. A., ed.), pp. 2901–2965. The Geological Society of America, Inc. & The University of Kansas, Boulder, Colorado, and Lawrence, Kansas.
- Ebbestad, J. O. R. & Högström, A. E. S. 2007. Ordovician of the Siljan District, Sweden. In *WOGOGO 2007 9th Meeting of the Working Group on Ordovician Geology of Baltoscandia. IGCP503 Ordovician Palaeogeography and Palaeoclimate. Regional Meeting 2007, August 17th–20th, Rättvik, Sweden, Field Guide and Abstracts* (Ebbestad, J. O. R., Wickström, L. M. & Högström, A. E. S., eds), *Rapporter och Meddelanden, Sveriges Geologiska Undersökning*, **128**, 128, 7–26.
- Egerquist, E. 1999. Early Ordovician (Billingen–Volkhov stages) brachiopod faunas from the NW Russia. *Acta Universitatis Carolinae, Geologica*, **43**(1/2), 341–343.
- Ernst, A. 2018. Diversity dynamics of Ordovician bryozoa. *Lethaia*, **51**, 198–206.
- Hammer, Ø. & Harper, D. A. T. 2006. *Paleontological Data Analysis*. Blackwell Publishing, 351 pp.
- Hansen, J. 2008. Upper Ordovician brachiopods from the Arnestad and Frognerkilen formations in the Oslo-Asker district, Norway. *Palaeontos*, **13**, 1–100.
- Hansen, J. & Harper, D. A. T. 2003. Brachiopod macrofaunal distribution through the upper Volkhov–lower Kunda (Lower Ordovician) rocks, Lynna River, St. Petersburg region. *Bulletin of the Geological Society of Denmark*, **50**, 45–55.
- Harper, D. A. T. 1986. Distributional trends within the Ordovician brachiopod faunas of the Oslo Region, south Norway. In *Les Brachiopodes fossiles et actuels* (Racheboeuf, P. R. & Emig, C. C., eds), *Biostratigraphie du Paléozoïque*, **4**, 465–475.
- Harper, D. A. T. 2000. Dalmanellidina. In *Treatise on Invertebrate Paleontology Part H: Brachiopoda, Revised. Volume 3: Linguliformea, Craniiformea, and Rhynchonelliformea (part)* (Kaesler, R. L., ed.), pp. 782–844. The Geological Society of America, Inc. & The University of Kansas, Boulder, Colorado, and Lawrence, Kansas.
- Harper, D. A. T. 2006. The Ordovician biodiversification: setting and agenda for marine life. *Palaeogeography, Palaeoclimatology, Palaeoecology*, **232**, 148–166.
- Harper, D. A. T. & Hints, L. 2001. Distribution and diversity of Ordovician articulated brachiopods in the East Baltic. In *Brachiopods, Past and Present* (Brunton, C. H. C., Cocks, L. R. M. & Long, S. L., eds), *Systematics Association Special Volume*, **63**, 315–326.
- Harper, D. A. T. & Hints, L. 2016. Hirnantian (Late Ordovician) brachiopod faunas across Baltoscandia: a global and regional context. *Palaeogeography, Palaeoclimatology, Palaeoecology*, **444**, 71–83.

- Harper, D. A. T., Cocks, L. R. M., Popov, L. E., Sheehan, P. M., Bassett, M. G., Copper, P., Holmer, L. E., Jin, J. & Rong, J.-Y. 2004. Brachiopods. In *The Great Ordovician Biodiversification Event* (Webby, B. D., Paris, F., Droser, M. L. & Percival, I. G., eds), pp. 157–178. Columbia University Press, New York.
- Harper, D. A. T., Owen, A. W. & Bruton, D. L. 2009. Ordovician life around the Celtic fringes: diversifications, extinctions and migrations of brachiopod and trilobite faunas at middle latitudes. In *Early Palaeozoic peri-Gondwana Terranes* (Bassett, M. G., ed.), *Geological Society, London, Special Publications*, **325**, 155–168.
- Harper, D. A. T., Rasmussen, C. M. Ø., Liljeroth, M., Blodgett, R. B., Candela, Y., Jin, J., Percival, I. G., Rong, J.-Y., Villas, E. & Zhan, R.-B. 2013. Biodiversity, biogeography and phylogeography of Ordovician rhynchonelliformean brachiopods. In *Early Palaeozoic Biogeography and Palaeogeography* (Harper, D. A. T. & Servais, T., eds), pp. 127–144. The Geological Society, London.
- Harper, D. A. T., Popov, L. E. & Holmer, L. E. 2017. Brachiopods: origin and early history. *Palaeontology*, **60**, 609–631.
- Harris, T. M., Sheehan, P. M., Ainsaar, L., Hints, L., Männik, P., Nõlvak, J. & Rubel, M. 2004. Upper Ordovician sequences of western Estonia. *Palaeogeography, Palaeoclimatology, Palaeoecology*, **210**, 135–148.
- Hints, L. 1973. New Orthacean brachiopods from the Middle Ordovician of the East Baltic area and Sweden. *Eesti NSV Teaduste Akadeemia Toimetised, Keemia, Geoloogia*, **22**, 248–256 [in Russian, with English summary].
- Hints, L. 1975. *Brakhiopody Enteletacea ordovika Pribaltiki [Ordovician Brachiopods Enteletacea of the East Baltic Area]*. Tallinn, 119 pp. [in Russian, with English summary].
- Hints, L. 1979. Genus *Saukrodictya* (Enteletacea) from the Ordovician and Silurian of Estonia. *Eesti NSV Teaduste Akadeemia Toimetised, Geoloogia*, **28**, 52–59 [in Russian, with English summary].
- Hints, L. 1986. Genus *Streptis* (Triplesiidae, Brachiopoda) from the Ordovician and Silurian of Estonia. *Eesti NSV Teaduste Akadeemia Toimetised, Geoloogia*, **35**, 20–26 [in Russian, with English summary].
- Hints, L. 1990a. Opyt primeneniya klasternogo analiza pri izuchenii faunisticheskikh assotsiatsij srednego ordovika Pribaltiki [Test of cluster analysis in the study of Middle Ordovician faunal associations of the East Baltic]. In *Proceedings of the XXXIII Session of the All-Union Paleontological Society*, pp. 87–94. Nauka, Leningrad [in Russian].
- Hints, L. 1990b. Ordovician articulated brachiopods. In *Field Meeting Estonia 1990. An Excursion Guidebook* (Kaljo, D. & Nestor, H., eds), pp. 58–61. Estonian Academy of Sciences, Tallinn.
- Hints, L. 1993. *Holorhynchus* (Pentamerida, Brachiopoda) in the Upper Ordovician of Estonia. *Proceedings of the Estonian Academy of Sciences, Geology*, **42**, 118–123.
- Hints, L. 2012. New Hirnantian orthide brachiopods from the type section of the Porkuni Stage (Porkuni quarry, northeastern Estonia). *Estonian Journal of Earth Sciences*, **61**, 227–241.
- Hints, L. 2014. Revision of the concept of the orthide brachiopod *Cyrtotrella* in the Middle Ordovician of the East Baltic. *Estonian Journal of Earth Sciences*, **63**, 63–70.
- Hints, L. & Harper, D. A. T. 2003. Review of the Ordovician rhynchonelliformean Brachiopoda of the East Baltic: their distribution and biofacies. *Bulletin of the Geological Society of Denmark*, **50**, 29–43.
- Hints, L. & Harper, D. A. T. 2015. The Hirnantian (Late Ordovician) brachiopod fauna of the East Baltic: taxonomy of the key species. *Acta Palaeontologica Polonica*, **60**, 395–420.
- Hints, L. & Põlma, L. 1981. Distribution of macrofossils and skeletal debris in the East Baltic Middle Ordovician. *Eesti NSV Teaduste Akadeemia Toimetised, Geoloogia*, **30**, 89–97 [in Russian, with English summary].
- Hints, L. & Rõõmusoks, A. 1997. Articulated brachiopods. In *Geology and Mineral Resources of Estonia* (Raukas, A. & Teedumäe, A., eds), pp. 226–228. Estonian Academy Publishers, Tallinn.
- Hints, L., Oraspõld, A. & Kaljo, D. 2000. Stratotype of the Porkuni Stage with comments on the Rõa Member (uppermost Ordovician, Estonia). *Proceedings of the Estonian Academy of Sciences, Geology*, **49**, 177–199.
- Hints, L., Paškevičius, J., Martma, T., Männik, P. & Nõlvak, J. 2016. Upper Sandbian–lower Katian bio- and chemostratigraphy in the Pajevonys-13 core section, Lithuania. *Estonian Journal of Earth Sciences*, **65**, 85–97.
- Jaanusson, V. 1956. Untersuchungen über den oberordovizischen Lyckholm-Stufenkomplex in Estland. *The Bulletin of the Geological Institutions of Uppsala*, **36**, 369–401.
- Jaanusson, V. 1976. Faunal dynamics in the Middle Ordovician (Viruan) of Baltoscandia. In *The Ordovician System. Proceedings of Palaeontological Association Symposium, Birmingham, 1974* (Bassett, M. G., ed.), pp. 301–326. Cardiff.
- Jaanusson, V. 1982. Ordovician in Västergötland. In *Field Excursion Guide* (Bruton, D. L. & Williams, S. H., eds), *Paleontological Contributions from the University of Oslo*, **279**, 164–183.
- Jaanusson, V. 1984. Ordovician benthic macrofaunal associations. In *Aspect of the Ordovician System* (Bruton, D. L., ed.), *Palaeontological Contributions from the University of Oslo*, **295**, 127–139.
- Kaljo, L., Hints, L., Hints, O., Männik, P., Martma, T. & Nõlvak, J. 2011. Katian prelude to the Hirnantian (Late Ordovician) mass extinction: a Baltic perspective. *Geological Journal*, **46**, 464–477.
- Kiipli, E. & Kiipli, T. 2013. Nitrogen isotopes in kukersite and black shale implying Ordovician–Silurian seawater redox conditions. *Oil Shale*, **30**, 60–75.
- Kiipli, E., Kallaste, T. & Kiipli, T. 2008. Hydrodynamic control of sedimentation in the Ordovician (Arenig–Caradoc) Baltic Basin. *Lethaia*, **41**, 127–137.
- Kröger, B., Hints, L. & Lehnert, O. 2014. Age, facies, and geometry of the Sandbian/Katian (Upper Ordovician) pelmatozoan-bryozoan-receptaculitid reefs of the Vasalemma Formation, northern Estonia. *Facies*, **60**, 963–986.
- Kröger, B., Hints, L. & Lehnert, O. 2017. Ordovician reef and mound evolution: the Baltoscandian Picture. *Geological Magazine*, **154**, 683–706.
- Lamansky, W. 1905. Die Aeltesten Silurischen Schichten Russlands (Etage B). *Mémoires du Comité Géologique, Nouvelle série, Livraison*, **20**, 1–203.
- Laškovas, J. 2000. *The Sedimentation Environments of the Ordovician Basin in the South-western Margin of the*

- East European Platform and Lithogenesis of Deposits*. Institute of Geology, Vilnius, 314 pp.
- Laškovas, J., Marcinkevičius, V. & Paškevičius, J. 1993. The stratigraphy and structure of Ordovician rocks of the south-east part of the Baltic Basin (Drūkšiai area). *Geologija (Vilnius)*, **14**, 81–98 [in Russian, with English summary].
- Männik, P. 2014. The Silurian System in Estonia. In *4th Annual Meeting of IGCP 591, The Early to Middle Palaeozoic Revolution. Estonia, 10–19 June 2014. Abstracts & Field Guide* (Bauert, H., Hints, O., Meidla, T. & Männik, P., eds), pp. 123–128. Tartu.
- Männik, P. & Viira, V. 2012. Ordovician conodont diversity in the northern Baltic. *Estonian Journal of Earth Sciences*, **61**, 1–14.
- Männil, R. 1959 *Voprosy stratigrafii i mshanki ordovika Éstonii [Problems on the Stratigraphy and Ordovician Bryozoans of Estonii]*. AN Éstonskoj SSR. Tallinn, 40 pp. [in Russian].
- Männil, R. 1960. Stratigraphy of the Oandu (“Vasalemma”) Stage. *Eesti Teaduste Akadeemia Geoloogia Instituudi Uurimused*, **5**, 89–122 [in Russian, with English summary].
- Männil, R. 1963. The biostratigraphic subdivision of the Ordovician in western Latvia. *ENSV Teaduste Akadeemia Geoloogia Instituudi Uurimused*, **13**, 41–74 [in Russian, with English summary].
- Männil, R. 1966. *Evolution of the Baltic Basin During the Ordovician*. Valgus Publishers, Tallinn, 200 pp. [in Russian, with English summary].
- Männil, R. 1976. Distribution of graptoloids in the Ordovician carbonate rocks of the East Baltic area. In *Graptolites and Stratigraphy* (Kaljo, D. & Koren, T., eds), pp. 105–117. Tallinn [in Russian, with English summary].
- Männil, R. 1986. Stratigrafiya kukersitonosnykh otlozhenij C1b–CIII [Stratigraphy of the kukersite-bearing beds of C1b–CIII]. In *Geology of the Kukersite-Bearing Beds of the Baltic Oil Shale Basin* (Puura, V., ed.), pp. 12–24. Valgus Publishers, Tallinn [in Russian].
- Männil, R. 1990. The Ordovician of Estonia. In *Field Meeting Estonia 1990. An Excursion Guidebook* (Kaljo, D. & Nestor, H., eds), pp. 11–20. Estonian Academy of Sciences, Tallinn.
- Männil, R. & Meidla, T. 1994. A. The Ordovician System of the East European Platform (Estonia, Latvia, Lithuania, Byelorussia, parts of Russia, the Ukraine and Moldova). In *The Ordovician System of the East European Platform and Tuva (Southeastern Russia)* (Webby, B. D., Ross, R. J. & Zhen, Y. Y., eds), *IUGS Publication*, **28**, A, 1–52.
- Meidla, T. 1997. Hunneberg Stage. Billingen Stage, Volkhov Stage. Kunda Stage. In *Geology and Mineral Resources of Estonia* (Raukas, A. & Teedumäe, A., eds), pp. 58–65. Estonian Academy Publishers, Tallinn.
- Meidla, T., Ainsaar, L., Hints, L., Hints, O., Martma, T. & Nõlvak, J. 1999. The mid-Caradocian biotic event in the Ordovician of the East Baltic. *Acta Universitatis Carolinae, Geologica*, **43**, 503–506.
- Meidla, T., Ainsaar, L. & Hints, O. 2014. The Ordovician System in Estonia. In *4th Annual Meeting of IGCP 591, The Early to Middle Palaeozoic Revolution. Estonia, 10–19 June 2014. Abstracts & Field Guide* (Bauert, H., Hints, O., Meidla, T. & Männik, P., eds), pp. 116–122. Tartu.
- Nestor, H. & Einasto, R. 1997. Ordovician and Silurian carbonate sedimentation basin. In *Geology and Mineral Resources of Estonia* (Raukas, A. & Teedumäe, A., eds), pp. 192–204. Estonian Academy Publishers, Tallinn.
- Nõlvak, J., Hints, O., Männik, P. & Pärnaste, H. 2007. Ordovician time scale in Estonia. *Acta Palaeontologica Sinica*, **46**, Supplement, 351–356.
- Õpik, A. 1928. Beiträge zur Kenntnis der Kukruse (C2–C3) Stufe in Eesti III. *Acta et Commentationes Universitatis Tartuensis (Dorpat)*, **A18**(11), 1–40.
- Õpik, A. 1930. Brachiopoda Protremata der Estländischen ordovizischen Kukruse Stufe. *Acta et Commentationes Universitatis Tartuensis (Dorpat)*, **A17**, 1–262.
- Õpik, A. 1932. Über die Plectellinen. *Acta et Commentationes Universitatis Tartuensis (Dorpatensis)*, **A23**(3), 1–85.
- Õpik, A. 1933a. Über Plectamboniten. *Acta et Commentationes Universitatis Tartuensis (Dorpatensis)*, **A24**(7), 1–79.
- Õpik, A. 1933b. Über einige Dalmanellacea aus Estland. *Publications of the Geological Institution of the University of Tartu*, **32**, 1–25.
- Õpik, A. 1934. Über Klitamboniten. *Publications of the Geological Institution of the University of Tartu*, **39**, 1–240.
- Oraspõld, A. 1956. New brachiopods from the Jõhvi, Keila and Vasalemma stages. *ENSV Teaduste Akadeemia Geoloogia Instituudi Uurimused*, **1**, 41–67 [in Russian].
- Oraspõld, A. 1959. Nekotorye predstaviteli nadsemejstva Orthacea iz verkhnego ordovika Éstonii [Some Upper Ordovician representatives of the superfamily Orthacea of Estonia]. *Tartu Riikliku Ülikooli Toimetised*, **75**, 51–81 [in Russian, with German summary].
- Paškevičius, J. 1973. *Biostratigrafiya, korrelyatsiya i graptolity ordovikskikh i silurijskikh otlozhenij yuzhnoj Pribaltiki [Biostratigraphy, Correlation and Graptolites of Ordovician and Silurian Deposits of the Southern East Baltic]*. Vilnius, 77 pp. [in Russian].
- Paškevičius, J. 1997. *The Geology of the Baltic Republics*. Vilnius University, Geological Survey of Lithuania, Vilnius, 387 pp.
- Paškevičius, J. 2000. Brachiopod communities of the Lithuanian facies zone in the Baltic Ordovician Basin. *Geologija (Vilnius)*, **32**, 14–35.
- Paškevičius, J. 2011. *The Ordovician and Graptolites of Lithuania*. LAP LAMBERT Academic Publishing, Saarbrücken, 107 pp.
- Paškevičius, P. 2016. Peculiarities of the lithology and fauna of the early Katian (Ordovician) in the Lithuanian facies zone. *Geologija, Geografija*, **2**(2), 49–61.
- Paškevičius, J. & Hints, L. 2016. New Early Katian species of Leptestiidae and Hesperorthidae (Brachiopoda) from Lithuania. *Estonian Journal of Earth Sciences*, **65**, 75–84.
- Rasmussen, C. M. Ø. & Harper, D. A. T. 2008. Resolving early Mid Ordovician (Kundan) bioevents in the East Baltic based on brachiopods. *Geobios*, **41**, 533–542.
- Rasmussen, C. M. Ø., Hansen, J. & Harper, D. A. T. 2007. Baltica: a mid Ordovician diversity hotspot. *Historical Biology*, **19**, 255–261.
- Rasmussen, C. M. Ø., Ullmann, C. V., Jakobsen, K. G., Lindskog, A., Hansen, J., Hansen, T., Eriksson, M. E., Dronov, A., Frei, R., Korte, C., Nielsen, A. T. & Harper, D. A. T. 2016. Onset of main Phanerozoic marine radiation sparked by emerging Mid Ordovician icehouse. *Scientific Reports*, **6**, 18884.

- Raukas, A. & Teedumäe, A. (eds). 1997. *Geology and Mineral Resources of Estonia*. Estonian Academy Publishers, Tallinn, 436 pp.
- Rõõmusoks, A. 1959. Strophomenoidea ordovika i silura Éstonii I, rod *Sowerbyella* Jones [Ordovician and Silurian Strophomenoidea of Estonia, genus *Sowerbyella*]. *Tartu Riikliku Ülikooli Toimetised*, **75**, 11–47 [in Russian, with German summary].
- Rõõmusoks, A. 1964. Nekotorye brachiopody iz ordovika Éstonii [Some Ordovician brachiopods from Estonia]. *Tartu Riikliku Ülikooli Toimetised*, **153**, 3–28 [in Russian, with English summary].
- Rõõmusoks, A. 1966. *Stratigrafiya viruskoj i har'yuskoj serij (ordovik) Severnoj Éstonii* [Stratigraphy of the Viru and Harju Series (Ordovician) of Northern Estonia]. A dissertation for the Doctor's Degree in geological and mineralogical sciences, Manuscript, Moscow–Tartu, 1227 pp. [in Russian].
- Rõõmusoks, A. 1970. *Stratigrafiya viruskoj i har'yuskoj serij (ordovik) Severnoj Éstonii* [Stratigraphy of the Viru and Harju Series (Middle Ordovician) in Northern Estonia]. Valgus Publishers, Tallinn, 346 pp. [in Russian].
- Rõõmusoks, A. 1981. Ordovician and Silurian Strophomenida of Estonia. III. Strophomenida. *Eesti NSV Teaduste Akadeemia Toimetised, Geoloogia*, **30**, 61–71 [in Russian, with English summary].
- Rõõmusoks, A. 1985. The genera *Trigrammaria* and *Microtrypa* (Strophomenidae) in the Ordovician of Baltoscandia. *Eesti NSV Teaduste Akadeemia Toimetised, Geoloogia*, **34**, 133–140.
- Rõõmusoks, A. 1991. On the stratigraphy and fauna of the boundary beds between the Pirgu and Porkuni stages of North Estonia. *Acta et Commentationes Universitatis Tartuensis*, **934**, 23–42 [in Russian, with English summary].
- Rõõmusoks, A. 2004. Ordovician strophomenoid brachiopods of northern Estonia. *Fossilia Baltica*, **3**, 1–151.
- Ropot, V. F. & Pushkin, V. I. 1987. *Ordovik Belorussii* [Ordovician of Belarus]. Publishers Nauka i Tekhnika, Minsk, 234 pp. [in Russian].
- Rubel, M. P. 1961. Brachiopody nadsemejstv Orthacea, Dalmanellacea i Syntrophiacea iz nizhnego ordovika Pribaltiki [Lower-Ordovician Brachiopods of the superfamilies Orthacea, Dalmanellacea and Syntrophiacea of Eastern Baltic]. *ENSV Teaduste Akadeemia Geoloogia Instituudi Uurimused*, **6**, 141–224 [in Russian].
- Rubel, M. 1963. O gonambonitakh (Clitambonitacea, Brach.) nizhnego ordovika Pribaltiki [On Baltic Lower Ordovician Gonambonitids (Clitambonitacea, Brach.)]. *ENSV Teaduste Akadeemia Geoloogia Instituudi Uurimused*, **13**, 83–108 [in Russian, with English summary].
- Rubel, M. 2011. Silurian brachiopods Dictyonellida, Strophomenida, Productida, Orthotetida, Protorthida and Orthida from Estonia. *Fossilia Baltica*, **4**, 1–63.
- Rubel, M. & Popov, L. 1994. Brachiopods of the subfamily Atelelasmatinae (Clitambonitacea) from the Arenig, Ordovician, of the Baltic Klint area. *Proceedings of the Estonian Academy of Sciences, Geology*, **43**, 192–202.
- Rubel, M. & Rõõmusoks, A. 1970. Brachiopody [Brachiopods]. In *Silurian of Estonia* (Kaljo, D. L., ed.), pp. 139–150. Valgus, Tallinn [in Russian, with English summary].
- Rubel, M. & Wright, A. D. 2000. Clitambonitidina. In *Treatise on Invertebrate Paleontology Part H: Brachiopoda, Revised. Volume 3: Linguliformea, Craniiformea, and Rhynchonelliformea (part)* (Kaesler, R. L., ed.), pp. 692–706. The Geological Society of America, Inc. & The University of Kansas, Boulder, Colorado, and Lawrence, Kansas.
- Rubel, M., Musteikis, P. & Popov, L. 1984. *Systematic List of East Baltic Silurian Brachiopods*. Preprint, Estonian Academy of Sciences, Tallinn, 36 pp. [in Russian].
- Schmidt, F. 1958. *Untersuchungen über die silurische Formation von Ehstland, Nord-Livland und Oesel. Archiv für Naturkunde Liv-, Ehst- und Kurlands. Erste Serie. Mineralogische Wissenschaften, bebtst Chemie, Physik und Erdbeschreibung. Zweiter Band*. Druck von Heinrich Laakmann, Dorpat. 248 pp.
- Schmidt, F. 1881. Revision der ostbaltischen silurischen Trilobiten nebstgeognostischer Übersicht des ostbaltischen Silurgebiets. Abt. I: Phacopiden, Cheiruriden und Encrinuriden. *Mémoires de l'Académie Impériale des Sciences de St-Petersbourg*, sér. 7, **30**(1), 1–238.
- Schmidt, F. 1907. Revision der ostbaltischen silurischen Trilobiten. Abt. VI. Allgemeine Übersicht mit Nachträgen und Verbesserungen. *Mémoires de l'Académie Impériale des Sciences de St-Petersbourg*, sér. 8, **20**(8), 1–104.
- Taylor, P. D. & Ernst, A. 2004. Bryozoans. In *The Great Ordovician Biodiversification Event* (Webby, B. D., Paris, F., Droser, M. L. & Percival, I. G., eds), pp. 147–156. Columbia University Press, New York.
- Tinn, O. 1998. The Ordovician Clitambonitidina brachiopod genus *Vellamo* in Estonia. *Proceedings of the Estonian Academy of Sciences, Geology*, **47**, 195–216.
- Törnquist, S. L. 1883. Öfversigt öfver bergbyggnaden inom Siljansområdet i Dalarna, med hänsyn företrädesvis fäst vid dess paleozoiska lag. Med en öfversigtskarta. *Sveriges Geologiska Undersökning, C*, **57**, 1–59.
- Tychsen, A. & Harper, D. A. T. 2004. Ordovician–Silurian distribution of Orthida (Palaeozoic Brachiopoda) in the Greater Iapetus Ocean Region. *Palaeontologia Electronica*, **7**(3), 1–15.
- Ulst, R. Z., Gailite, L. K. & Yakovleva, V. I. 1982. *Ordovician of Latvia* [Ordovik Latvii]. Zinatne, Riga, 294 pp. [in Russian].
- Walcott, C. 1912. Cambrian Brachiopoda. *United States Geological Survey, Monographs*, **51**, part I, 1–812, part II, 1–363.
- Warburg, E. 1910. Geological description of Nittsjo and its environs in Dalarna. *Geologiska Föreningens i Stockholm Förhandlingar*, **32**, 425–450.
- Webby, B. D. 2004. Introduction. In *The Great Ordovician Biodiversification Event* (Webby, B. D., Paris, F., Droser, M. L. & Percival, I. G., eds), pp. 1–37. Columbia University Press.
- Williams, A. 1976. Plate tectonics and biofacies as factors in Ordovician correlation. In *The Ordovician System* (Bassett, M. G., ed.), pp. 29–66. University of Wales Press & National Museum of Wales, Cardiff.
- Williams, A. & Carlson, S. J. 2000. Class Rhynchonellata. In *Treatise on Invertebrate Paleontology Part H: Brachiopoda, Revised. Volume 3: Linguliformea, Craniiformea, and Rhynchonelliformea (part)* (Kaesler, R. L. ed.), pp. 708–840. The Geological Society of America, Inc. & The University of Kansas, Boulder, Colorado, and Lawrence, Kansas.
- Williams, A. & Harper, D. A. T. 2000. Orthidina. In *Treatise on Invertebrate Paleontology Part H: Brachiopoda, Revised. Volume 3: Linguliformea, Craniiformea, and*

- Revised. Volume 3: Linguliformea, Craniiformea, and Rhynchonelliformea (part)* (Kaesler, R. L., ed.), pp. 714–782. The Geological Society of America, Inc. & The University of Kansas, Boulder, Colorado, and Lawrence, Kansas.
- Wright, A. D. 1976. *Rotten Shells*. The Queens's University of Belfast, privately printed, 26 pp.
- Zhan, R.-B., Jin, J., Zhang, Y.-D. & Yuan, W.-W. 2008. The great Ordovician radiation of marine life: examples from South China. *Progress in Natural Science*, **18**, 1–12.
- Zuykov, M. A. 1999. *Platystrophia* (Orthida, Brachiopoda) from the Arenig and lowermost Llanvirn of northwestern Russia. *Proceedings of the Estonian Academy of Sciences, Geology*, **48**, 195–212.

Brahhiopoodide mitmekesisuse muutumine ja biostratigraafiline tähtsus Balti Ordoviitsiumis

Linda Hints, David A. T. Harper ja Juozas Paškevičius

On esitatud andmed ligi 500 brahhiopoodi taksoni levikust 106 Ordoviitsiumi-Siluri läbilõike erinevas stratigraafilises üksuses (lademes, alamlademes, kihistus või kihistikus), mis on eristatud Baltikumi eri piirkondades (Eestis, Lätis, Leedus ja Valgevenes). On analüüsitud brahhiopoodide taksonoomilise koosseisu muutusi ajas ja võrreldud seda sammalloomade koosseisu muutustega. Töös on kasutatud varem publitseeritud, kuid taksonoomiliselt ja stratigraafiliselt korrigeeritud ning uusi andmeid liikide leviku kohta (on esitatud lisadena seitsmes tabelis). Tänapäeval on makrofossiilide, sealhulgas brahhiopoodide kasutatavus biostratigraafias oluliselt vähenenud, kuivõrd läbilõigete korreleerimiseks ja biostratigraafiliste piiride määramiseks on hõlpsam rakendada erinevaid mikrofossiile. Käesoleva töö eesmärgiks on näidata brahhiopoodide kasutatavust biostratigraafias, tuginedes nende liigilise koosseisu erinevustele stratigraafilistes üksustes. Selleks on kasutatud Hamneri ja Harperi (2006) väljatöötatud Past3 programmi kobaranalüüsi. Brahhiopoodide leviku põhjal dendrogrammides eristuvad kobarad seostuvad basseini šelfialadel (Eestis ja Leedus ning Valgevenes) küllaltki hästi Ordoviitsiumi lademelise ja ladejärgulise jaotusega. Kobaranalüüsi põhjal ilmnevad Balti basseini brahhiopoodifauna arengus selgelt kolm etappi, mis hõlmavad vastavalt: 1) Hunnebergi kuni Kunda (Aseri?), 2) Aseri kuni Keila ja 3) Oandu kuni Porkuni lademe. Dendrogrammid näitavad ka etapiseseid seoseid. Etappe iseloomustavad ka liigilise mitmekesisuse muutused ajas. Kobaranalüüsi kasutamine erinevate stratigraafiliste üksuste või kivimkehade faunade uurimisel mitte ainult ei esita näitlikult nende faunistilisi seoseid, vaid toovad esile ka võimalikke revisjoni või edasist uurimist vajavaid aspekte biostratigraafias.